



QUICK START GUIDE

RCP-6301 VINYL CUTTER



RICOMA INTERNATIONAL CORPORATION

11555 NW 124th St, Miami, FL 33178













Telephone: (305) 418-4421 | Toll Free: 1-888-292-6282



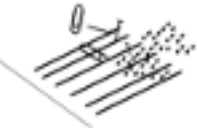

Fax: (305) 418-5036 | Email: info@ricoma.com

ricoma.com

Copyright ©2021 Ricoma
All rights reserved

DEFINITION OF SYMBOLS

	Warning. Any improper operation may result in a hazard of life or damage to equipment.
	A warning symbol for the possibility of electrical shock.
	The symbol in the circle represents actions that are not allowed.
	Do not use the power source that does not meet the voltage rating; otherwise, fire or electric shock may occur.
	If smoke or a strange odor is coming out of the machine, or it makes a loud sound, this means the machine is not functioning properly and you should discontinue use. If you continue using it, it may result in fire or an electric shock.
	Do not take out the plug when the power is on to avoid damage to the machine.
	Make sure your machine is grounded, otherwise you may experience an electric shock or a mechanical failure.
	Do not detach, repair or reconstruct the machine; otherwise, fire, electric shock, or other life hazards may result.
	Do not leak any liquid or drop metal into the machine, such things may result in fire.
	Do not touch the top of the knife with your finger to prevent injury or dulling of knife head.
	Do not damage or replace the supplied power cable on your own. Do not excessively bend, pull, bundle or place weight on the power cable. Otherwise, the power source may be damaged and electrical shock or fire may occur.
	If you are not going to use the machine for a long time, please unplug the power cable from the receptacle to avoid fires or electrical shortages from occurring.

	<p>When operating the machine, do not place either of your hands on capstan to avoid injury.</p>
	<p>Place the machine on a stable surface; otherwise, the machine may fall and get damaged.</p>
	<p>To unplug the power cable from the outlet, please grab the plug instead of the cable. Pulling the cable with too much force may result in an electrical shock or fire.</p>
	<p>Any operation is forbidden in case of storms or lightning to prevent damage of the machine.</p>
	<p>Do not pull the cartridge by hand to avoid damage to the mainboard when the plotter is powered on.</p>

STANDARD ACCESSORIES

Item	Part	Quantity
1	Power cord	1
2	USB Cable	1
3	Blade holder <i>* In machine</i>	1
4	Blade <i>* 1pc in machine</i>	3
5	Pen and pen holder	1
6	Signmaster	1
7	User Manual	1

QUICK START

1

Step 1

Assemble the floor stand (if you have floor stand) (**Refer to File 1.1**)

2

Step 2

Install USB driver (**Refer to file 1.2**)

Install Signmaster (in the kit-box) (**Refer to File 1.3**)

3

Step 3

1. Connect the plotter and computer with original black cable (Option 1)

2. Connect the cutter and computer with Ethernet cable (Option 2)

3. Use Your U-disc (USB flash drive) to insert the cutter port (Option 3)

4

Step 4

Basic cut: Design your work and cut in Signmaster (**Refer to File 1.3**)

Contour cut: Design your work and contour cut in Signmaster (**Refer to File 1.4**)

Contour cut from U-disc: (**Refer to File 1.5**)

Note:

1. Signmaster online download address:

http://fcws6.com/downloads/signmaster/craft/SignMaster_UniverCraft.exe

2. Please DO NOT lose the Signmaster PSN code. If you need to change computers to install Signmaster, please deactivate it before installing it in another computer.

3. Computer support: All Windows systems.

4. If you encounter any problem, please refer to "FAQ" to get the solution.

USB DRIVER INSTALLATION

To connect the plotter to the computer by USB cable, turn on the cutting plotter. Go to CD-ROM drive on your computer, locate the folder drive, open the folder, double-click "USB Driver Setup." After, your computer should display the following window:

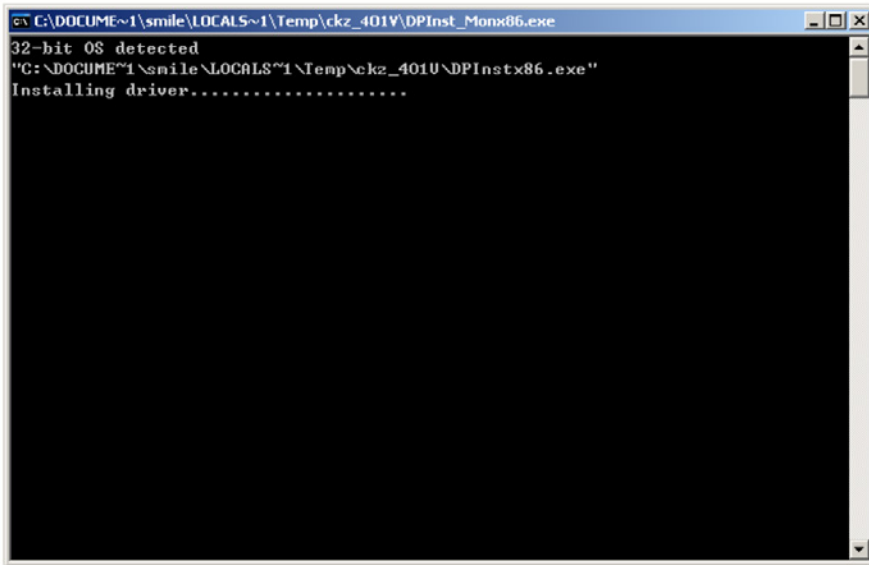

After driver installation, windows will close automatically. Computer will display the following window. Click "Next".

Click "Finish".

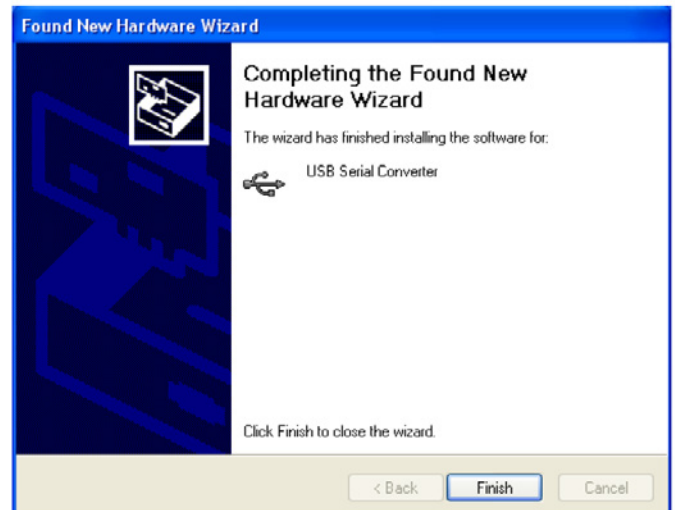
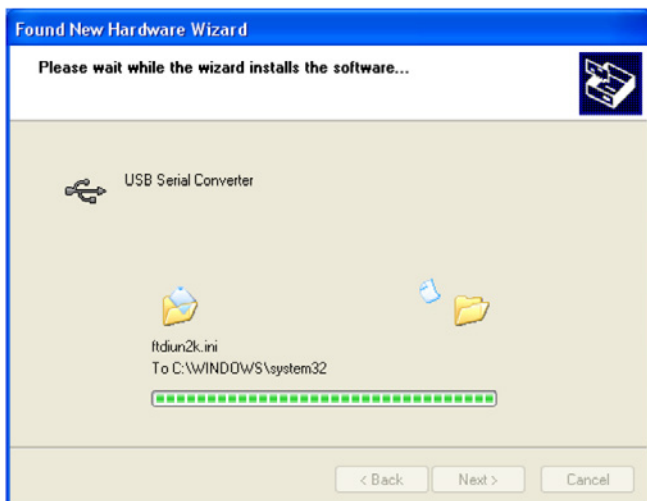

Set up steps:

Click “My Computer” in the pop-up shortcut menu, then click “Properties”. The dialog box pop-up should be as follows:

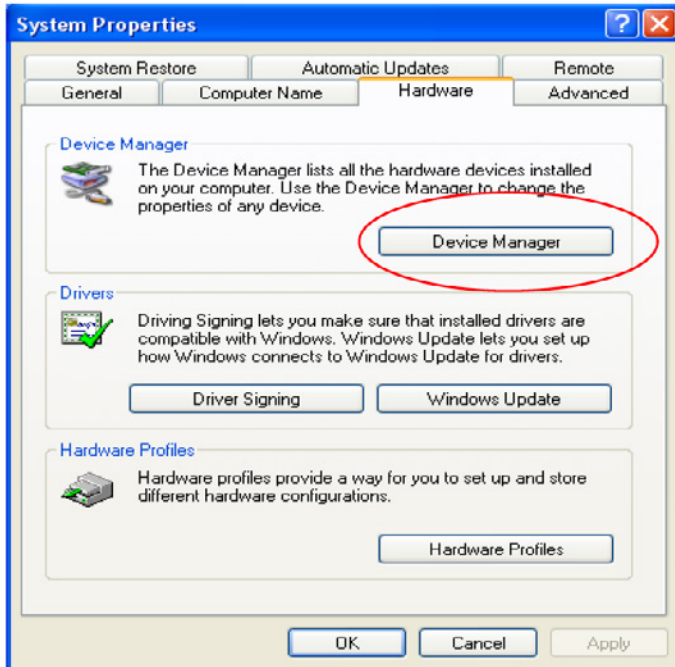

Click “Device Manager” and select “USB Serial Port (COM3)” as follows:

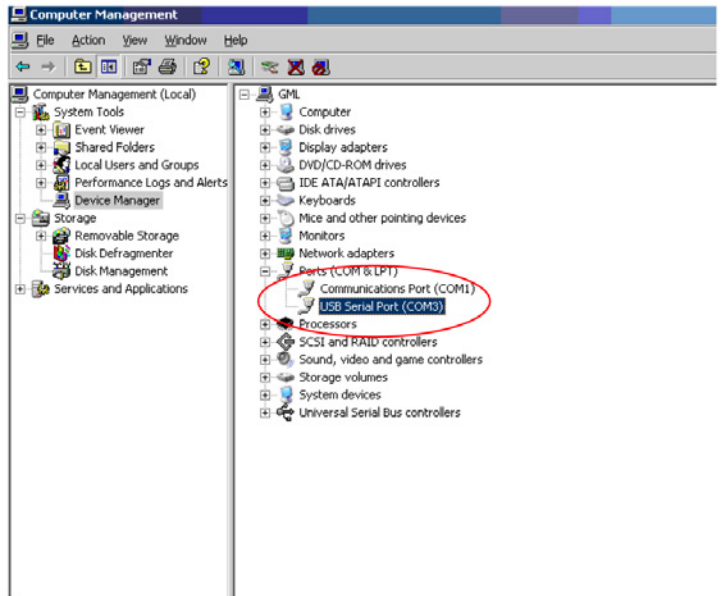

Click “Advanced”.

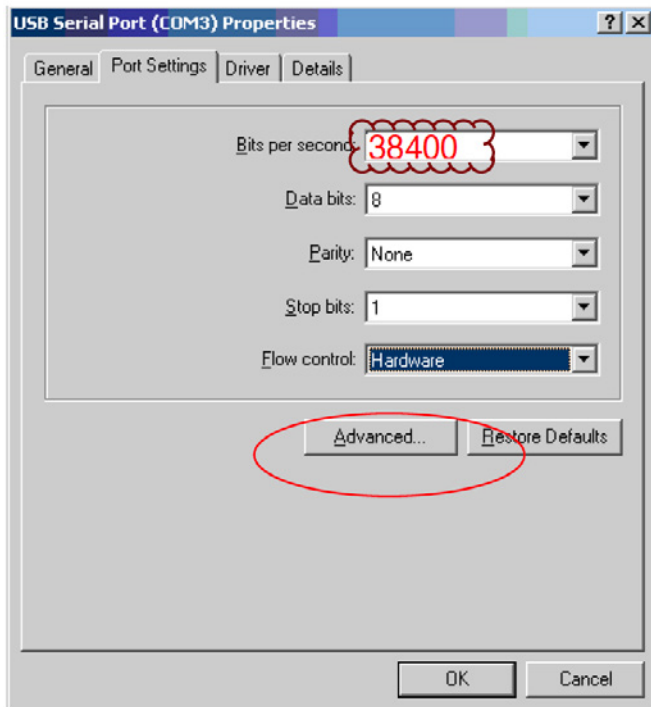



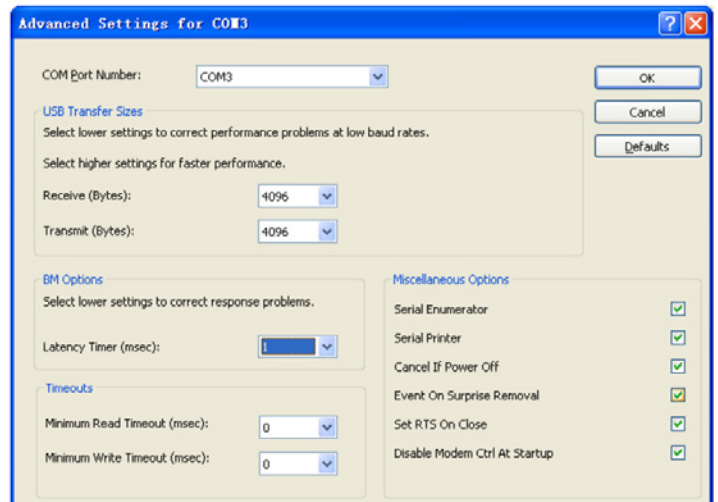

To change the port number, click on the “COM Port Number” drop down box to select the correct port number.



INSTALLATION

3.1 Machine Installation and connections



	WARNING
	Make sure machine is grounded; otherwise, electric shock or mechanical failure may occur.
	Do not use a power source that does not meet the recommended voltage requirement. Using the wrong power source may result in fire or electrocution.
	Don't pull out the plug when the power is on to avoid damage to the machine.
	Place the machine on a stable surface; otherwise, the machine may fall and get damaged.

3.1.1 Place the cutter in a flat and spacious area.

3.1.2 Connect the cutting plotter to computer by USB cable or put a U-disc directly in the cutter.

3.1.3 Check power and voltage. Do not connect to power until you ensure the connection is grounded and is the proper voltage.

3.2 Installation cutting tool

	CAUTION
	Don't touch the top of the blade with your finger to prevent injury.

3.2.1: Adjust the protruding length of the blade top as required for specific cutting media.

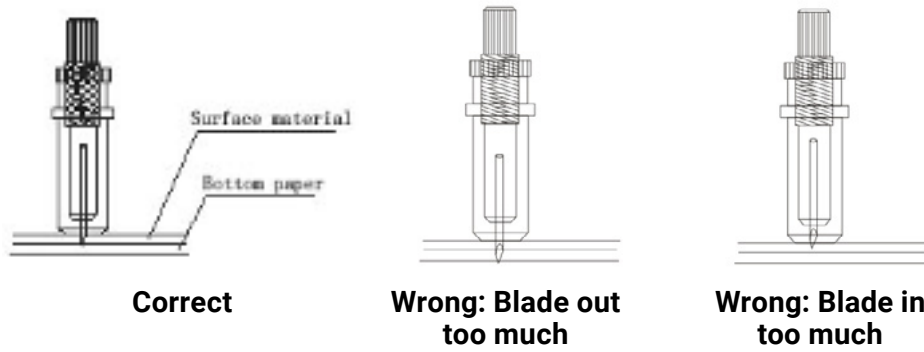

3.2.2

- (1) Loosen the screw of the blade holder.
- (2) Place the blade into the blade holder attached to the carriage.
- (3) When the blade is in the appropriate position, tighten the screw.

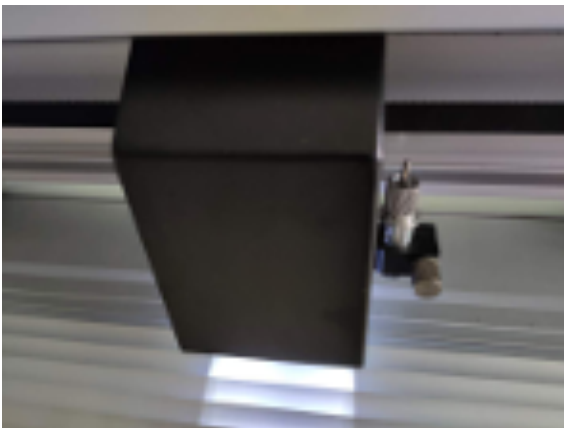

Loosen

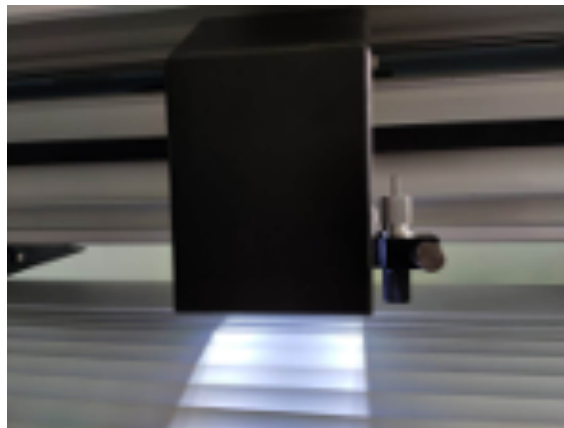

Correct position for blade holder

Note: There are two options to install cutting software, one is Signmaster, the other is CorelDRAW plugin (or dongle).

3.3A Signmaster software installation (Recommended)

1. Open the Signmaster package, and insert the CD into your computer. Install and fill in the PSN code to activate.
2. Change language if needed and then choose the cutting plotter model that corresponds to your cutter in the Signmaster software.
3. Follow the Signmaster operation manual for more details and watch the informational video to learn what a basic cut and contour cut are.

Contour cut: Please refer to your Signmaster software manual.



Basic Cut: Import vector file, or write the letters of your choosing, then click the Blade Tool and start cutting. You can set the offset and overcut setting under the Properties-Cut option or through your connection. (Connection can be through Windows port-file/Direct COM part when linked with any computer with a Windows system.)

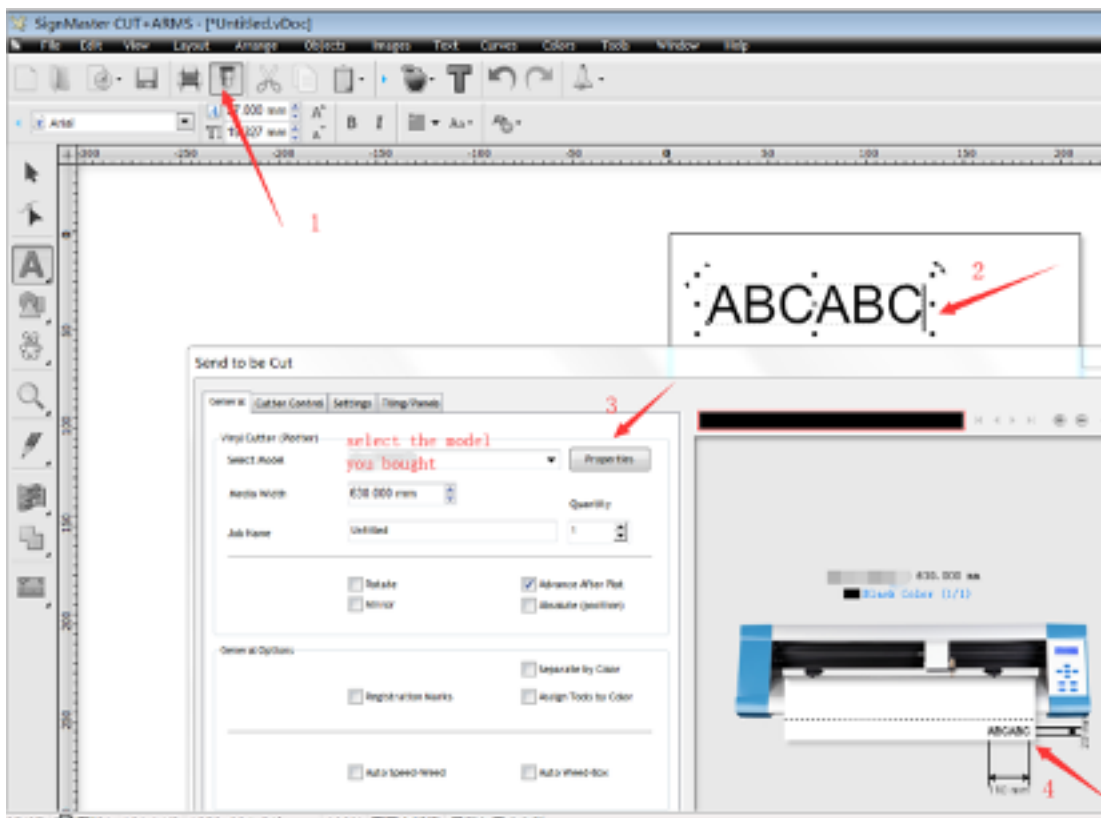

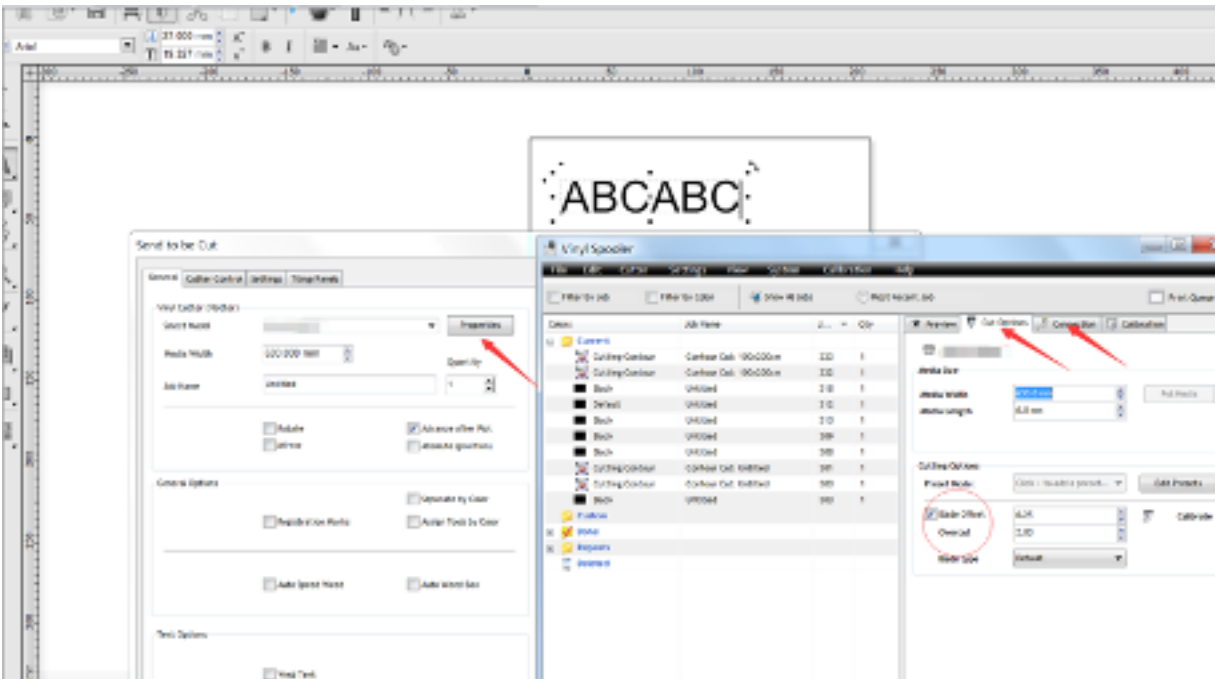

Note: Adjust the blade offset/overcut setting if it is cutting poorly. Camera Contour Cut: Please check the operation video guide.

More Signmaster user guide videos:

1. How to use Signmaster to design:

http://iifuture.org/vmtuts/getVMTut.php?key=smc_full_ht_use&r=0

3. How to contour cut:

http://iifuture.org/vmtuts/getVMTut.php?key=smc_full_ht_contour_cut&r=0

4. Contour cutting with ultra marks:

http://iifuture.org/vmtuts/getVMTut.php?key=smc_full_ultramarks&r=0

5. Working with templates:

http://iifuture.org/vmtuts/getVMTut.php?key=smc_full_templates&r=0

3.3B Computer installation (If working with CorelDRAW):

Note: Due to customers using different versions of CorelDRAW (including cracked versions), the dongle might not match, so it's best to use Signmaster.

CUTTING PLOTTER INSTRUCTIONS

4.1 Name and function of parts

4.1.1 Front view

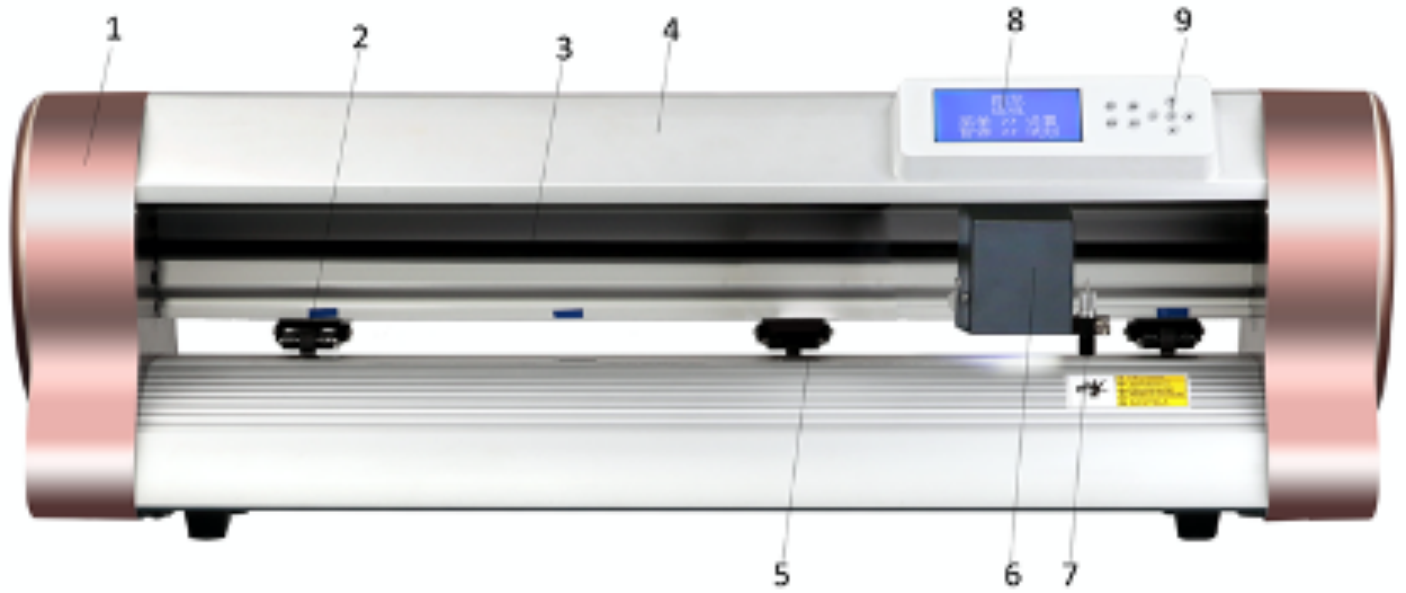

Side 1



Side 2





- | | |
|------------------------|-----------------------|
| 1. Left cover | 8. LCD display |
| 2. Pinch roller wheels | 9. Keypad |
| 3. Carriage belt | 10. Network port |
| 4. Upper cover | 11. USB port |
| 5. Grit roller | 12. U disc port |
| 6. Carriage | 13. Power supply port |
| 7. Blade holder | 14. Switch |

4.1.2 Keypad and display



- 1: Go back 2: Forward 3: Go left 4: Go right 5: Online
6: Menu 7: Pause 8: Reset 9: Original 10: LCD

4.2 Basic operation

	CAUTION
	When switching on the power, make sure your hands and other objects are not in the way of the main shaft or slider to prevent injury.

4.2.1 Turn on machine

4.2.1.1 Check whether the power is in the OFF position.

4.2.1.2 Plug the cable into the power source and press the power switch.



4.2.2 Installation of cutting media

This machine is suitable not only for single-sheet media, but also a roll of media.

4.2.2.1 Press down the handle of pinch roller behind the machine to raise the handle.



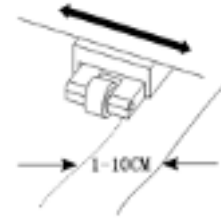

4.2.2.2 Insert the media into the space between the pinch roller and grit roller, and pull out media to the appropriate length at the front.

4.2.2.3 Adjust the horizontal position of the paper weight wheel according to the width of the paper. A minimum distance of 1 to 10CM is recommended between the paperweight wheel and the edge of the paper to ensure the paper runs smoothly through the cutter.



4.2.2.4 Raise the pinch roller to make the paperweight wheel press down on the paper.

4.2.3 To test your cutting blade, adjust the blade press and knife position.

	CAUTION
	Do not touch the top of the knife with your finger to prevent injury.

The quality of the knife is directly correlated to the cutting precision and life of the machine. To better your work, please use the standard knives we provide or recommend. Do not use poor-quality knives.



4.3 Cutter operation instruction and parameter setting:

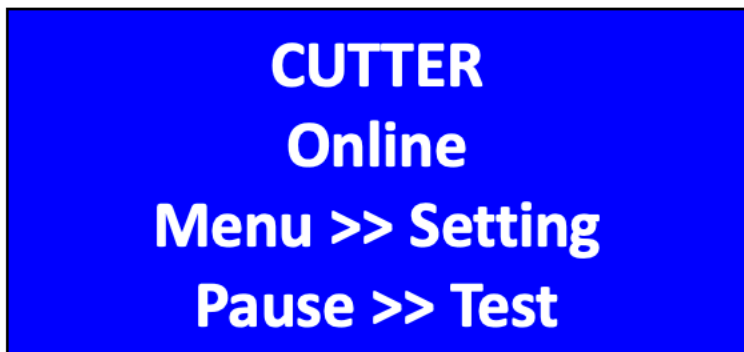

When the cutter is open, the cutter will go to the original position and you will see the display below on your cutter.

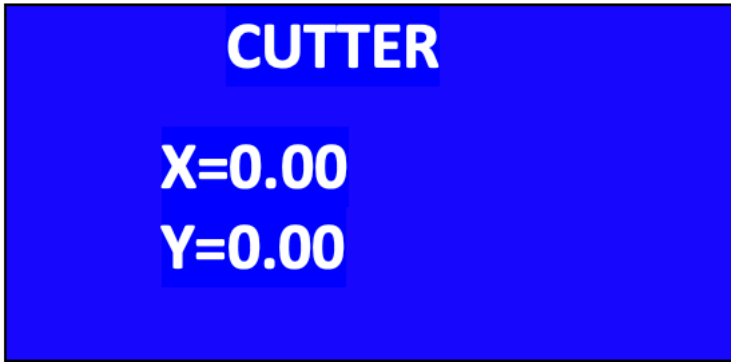

4.3.1 Press “Online” and you will see the screen below:







Press Left  and Right  to change the value of X to make the carriage head move.

Press Up  and Down  to change the value of Y to make the cutting material move.





4.3.2 Press “Menu” and you will see the screen below:

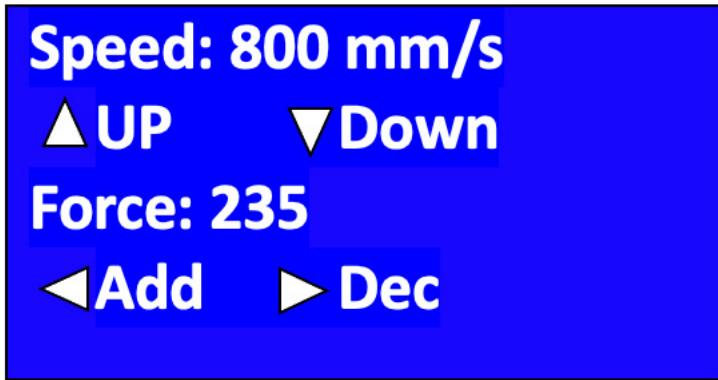

The cutter can read the U-disk directly. You can copy the design that you want to cut from the U-disc and then put it into the cutter’s U-disk port. The cutter will then show the files inside the U-disc. Press the  button first to scan the files, then press Up  or Down  to review the file. Find the right plt format file. Then press  to confirm it. Then set the number of repeats and the distance between the pieces you are cutting. Press  again and the camera will scan the marks and start to cut.

2) Press “Menu” again and you will see the screen below:



Press Up  to increase the speed. Press Down  to decrease the speed.
Press Left  to increase the force. Press Right  to reduce the force.

3) Press “Menu” again and you will see the screen below:



The cutter will remember the last job sent from the computer to the cutter. To re-cut the previous design, press  to execute the previous cutting.

3) Press “Menu” again and you will see the screen below:



Under this interface, you can press Up or Down to change the language. We provide two languages: English and Chinese. The default language is English.

4) Press **"Menu"** again and you will see the screen below:

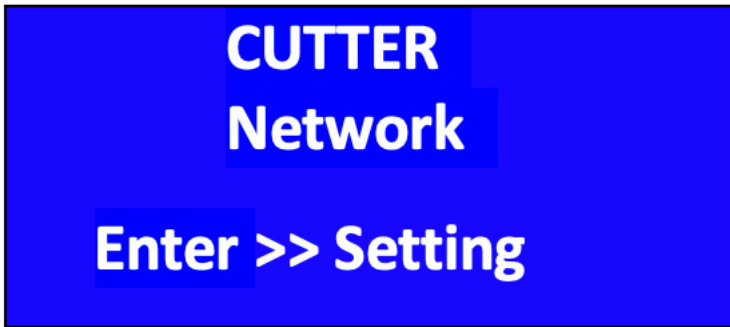

4.1) Press  and you will see the screen below:

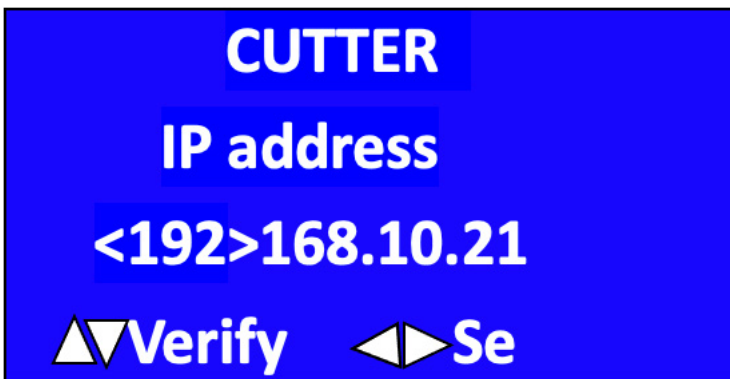

Press Left  and Right  to select the numbers.

Press Up  and Down  to change the numbers.

Check the computer's IP address first, and then make sure the plotter's IP address is different. If they are the same, then change the last number of the plotter's IP address. Signmaster's IP address should be the same as the plotter.

4.2) Press **"Menu"** again and you will see the screen below:

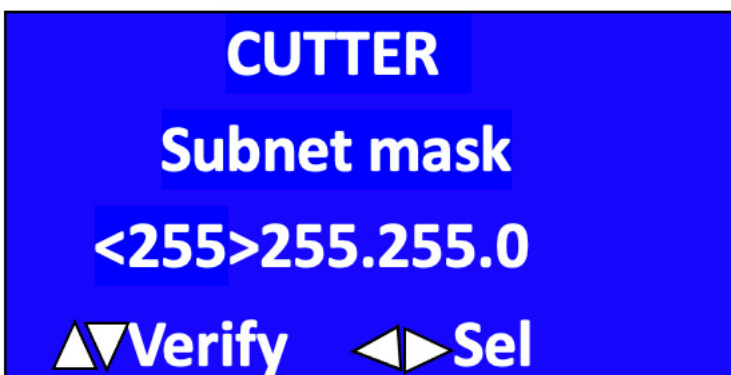

4.3) Press "**Menu**" again, you will see the screen below:

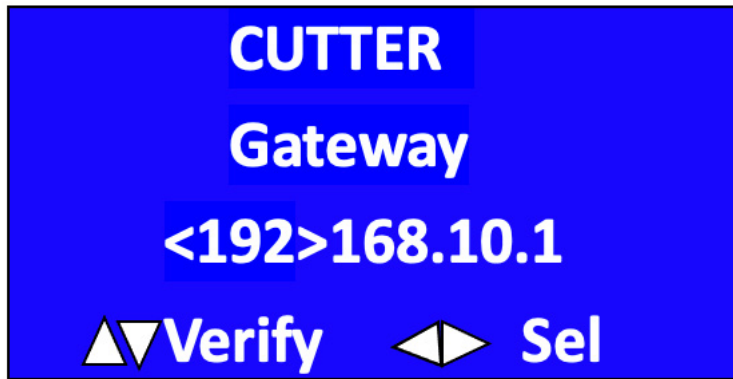

You do not need to change any of the above settings. Only an authorized technician should adjust these settings.

4.3.3 Press  and you will see the screen below:

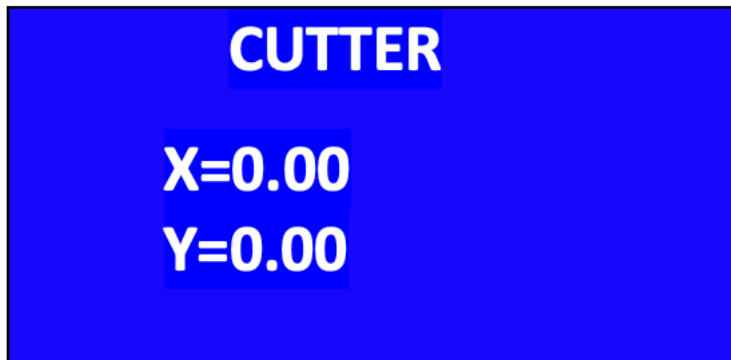

4.3.4 Press the "**Reset**" button and the cutter will go back to its original position. You will see the screen below after you press the reset button:

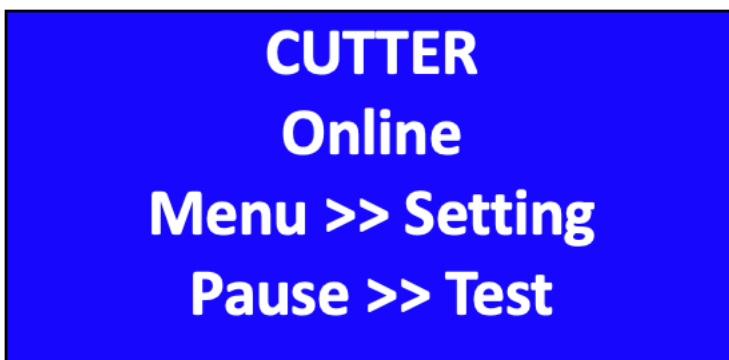

4.3.5: Press “Pause” when the cutter is not cutting, to cut a small test square. You can judge the cutting blade’s length by this test. Press “Pause” during cutting to stop the plotter. Press “Pause” again to continue cutting.

4.4 Knife off-setting

4.4.1 If your knife is not close enough during cutting, you need to reset the offset in your cutting software, which should look like the figure below (please follow the manual provided with your software).



No offset



With offset

4.5.2 During cutting, if you don’t see right angles, please adjust the sharp-angled compensation in the cutting software (ATTENTION: The offset value can be over or under, so follow the image below to properly set the compensation in your software.)



Correct



Not enough

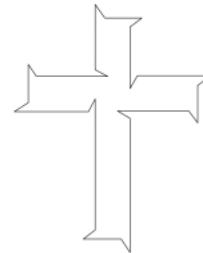

Over

When you are using cutting software, we recommend you select the high precision output.

5.1 Question: Will the characters below 1cm come out misshapen or deformed because they are too small?

Answer: When cutting small characters, please set offset in the software. For example, in “Artcut” sign software:

- (1). Click **“plotting output”** once, a plotting output picture will pop up.
- (2). Click **“set”** once, a picture of setting plotter will pop up.
- (3). Click **“compensation setting”**, a dialog box will pop up.
- (4). Select **“sharp-angle compensation”**, adjust the value to required level.

The compensation ranges between 0.1 to 0.7 but we advise setting it to 0.25. In addition, the plotting speed of the cutter should be set below 10.

5.2 Question: Why is there an additional stroke after finishing cutting?

Answer:

- (1). Check if the tip of cutter is flexible when it is up and down.
- (2). Check the Signmaster software to see if some of the letters have any issues.
- (3). Check if there are some problems on the files.

5.3 Question: Why does zigzagging happen to the cutter?

Answer: Because the cutter motor features high power and speed, the cutting speed should be adjusted according to the size of the character you are trying to cut. Generally, to cut small glossy characters with high precision, the speed should not exceed 65. In most cases, a speed of 65 is favorable. To cut big characters of large quantities within the shortest amount of time, the speed can be set up to 350. However, since the step distance of the motor is so long, noticeable zigzagging may occur. Therefore, you should set the speed to the specific size of the characters in order to prevent zigzagging. To see the relationship between speed and character size, please refer to the following table:

Size of font (mm)	Speed (mm)
2-10	5
10-30	80-200
30-50	200-350
50-500	350-500
>500	500

5.4 Question: Why does the paper deviate when it runs by a large margin?

Answer: The paper feed containing the paper roll will be completely parallel to paperweight wheel. For a big roll of materials, loosen it prior to cutting to prevent excessive obstruction when plotting or graving. For the machines with four paperweight wheels, when plotting big images or characters back and forth, use the two paperweight wheels at the sides instead of pressing the four down simultaneously. Unequal abrasion of the two wheels also may result in deviation of the paper; in the worst case, you may need to replace the wheels.

5.5 Question: Why does lock up happen in plotting output?

Answer: (1) Exterior 220V input voltage is too low (150V), causing the plotter to restart and lock up.
(2) When disturbance of exterior 220V input voltage is too high, lock up may happen. To resolve this issue, use a purified and regulated power source.

5.6 Question: Why does the machine feel electrically charged?

Answer: The machine might be improperly grounded. Make sure the central line of the power source is grounded.

5.7 Question: Why does the job feel rough or has sharp raised angles when plotting?

Answer: (1) The protruding length of the knife tip is too long, please adjust it as required.
(2) The knife is dull, replace it.

5.8 Question: Why does the plotter first cut a line before plotting?

Answer: Because the machine did not properly finish the previous job and there is still knife-dropping instructions in the plotter's memory. To resolve, power off the machine and turn it back on.

5.9 Question: Why is there no LCD display? Why is there a row of black blocks on the display

Answer: (1) If there is no display, check whether the power is working well or not.
(2) If there are black blocks displayed, check whether voltage is at the required level. If the problem persists after the above step, please contact a maintenance center.

5.10 Question: Why can't the letters be close in strokes when it is plotting?

Answer: Because the knife is at an incorrect angle. To resolve, adjust the "closing compensation" in the software. For example, in "Artcut" software:

- (1) Click "plotting output" once, a plotting output picture will pop up.
- (2) Click "set" once, a picture of setting plotter will pop up.
- (3) Click "compensation setting," a dialog box will pop up.
- (4) Select closing compensation, adjust the value to required level. Generally the value is set to 0.5.

5.11 Question: Why is the machine not paving some of the letters when cutting?

Answer: (1) Check if the machine is applying enough pressure.
(2) Reinstall the software.
(3) Check the head of the knife.
(4) If the problem persists, contact the repair center.

5.12 Question: Why is the machine in a low-speed state after starting up?

Answer: Because the paper sensor failed to detect the end of paper. When feeding the end of the paper into the cutter, make the end of the paper cover the hole of the paper sensor, then perform another automatic paper testing.

5.13 Question: Why are some cuts deep while some are shallow?

Answer: CT employs upscale soft PVC materials as a knife strip cushion to protect the cutting blade. However, using it for long periods of time may wear down the cushion and make it rough, resulting in some deep cuts and shallow cuts. To resolve this, replace the knife strip cushion. If it is not worn down completely, adjust knife as described in section 3.2.1, or increase knife press to 350.

5.14 Question: Why can't the plotter run when it is outputting?

Answer: (1) Check whether the plotter is properly connected with computer. The cutter is connected with COM1 or COM2 of computer; confirm whether the set ports are connected.

(2) Check whether the plotter is in online state, namely whether the LCD displays "ONLINE".

(3) Check whether the encryption card of the software is properly installed. If not, please turn off the power and reinstall it.

5.15 Question: Why can't the instant-glue be taken off?

Answer: (1) Perform a trial run prior to selecting output and adjust the press to the appropriate level.

(2) Check whether the knife is dull, or whether the top of the knife is broken. For new knives, the cut is thin in the instant-glue, while for old ones the cut is thick.

5.16 Question: What should I do when cutting big characters?

Answer: (1) When cutting big characters, the system can automatically be set to use several pages, but the width setting will conform to the width of the instant-glue. In addition, when cutting big characters and setting the output, you should widen the pages or set the seaming distance.

(2) When you use the special wide machine to cut the big characters, especially the long and big characters, look at the paper first before setting the cutting input to ensure the big characters won't deviate the paper you are using and waste it.

5.17 Question: How do I maintain the plotter?

Answer: The MK series plotter is self-lubricating, so no oil is needed, even if used for a long time. After daily use, clean the dust with a soft brush. The glue remaining in engine base can be cleaned with alcohol. If frequently operated in a dusty environment for more than 2 years, please have maintenance technicians clean the dust in the machine. If plotting starts losing precision, take the machine for a maintenance check to replace any degraded parts.

5.18 Question: Why does the plotter seem out of our control sometimes?

Answer: Maybe while transporting or using it, the signal line was disconnected. To fix this, open the machine and properly plug in all signal lines. If the problem persists, please contact a local agent or

maintenance center.

5.19 Question: Why does the plotter come to a halt?

Answer: The plotter knife may have been vibrating for too long, or it may have been used for a long period of time, so you should discontinue use. If it seems to be overheating, please unplug it as a dielectric displacement of the servo driving board may have occurred. If this is the case, contact a local agent or customer maintenance center.

FLOOR STAND ASSEMBLING INSTRUCTION

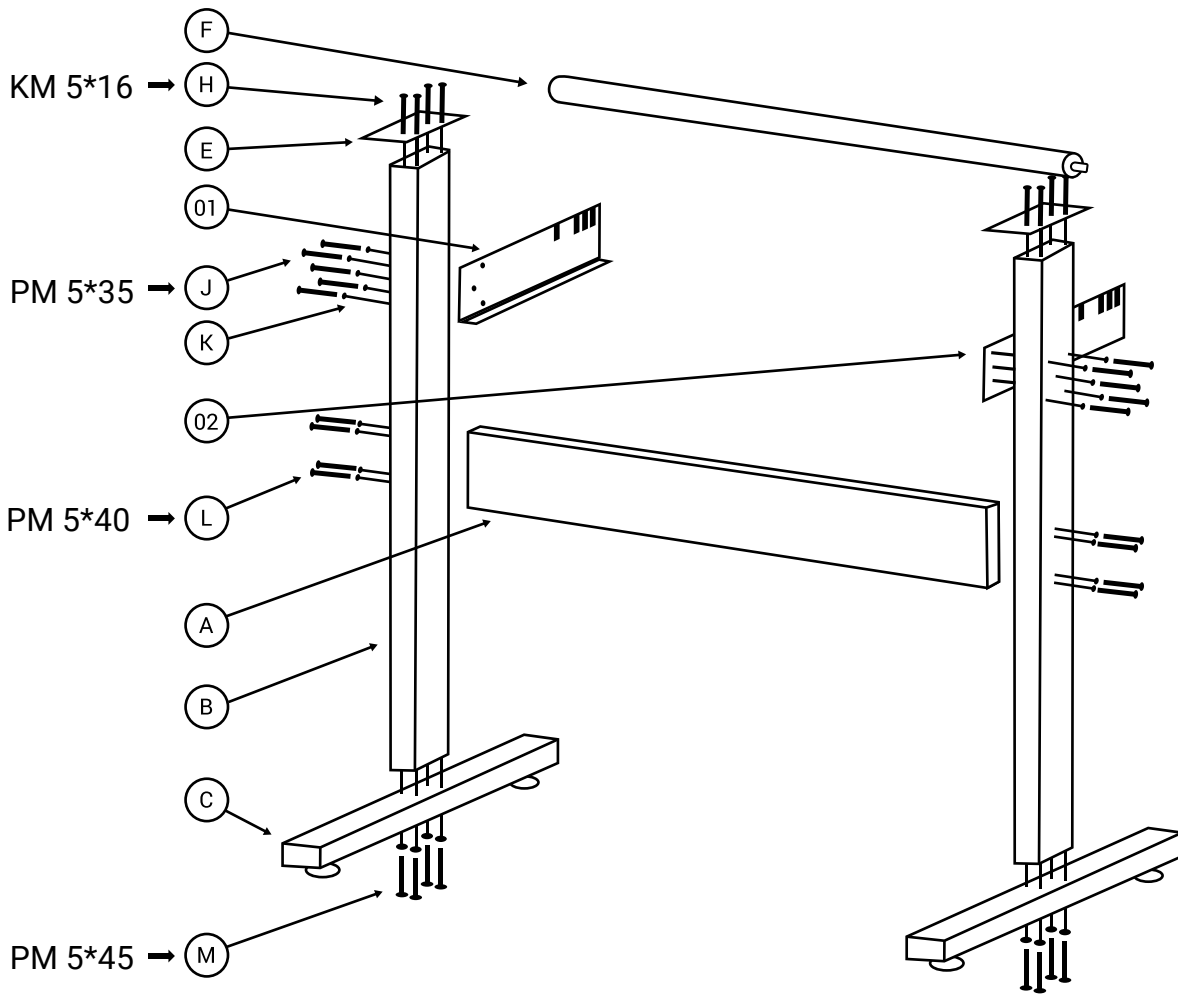







Table screws and instructions:

- H: KM 5*16...8pcs
- J: PM 5*35...10pcs
- L: PM 5*40...8pcs
- M: PM 5*45...8pcs

-  KM 5*16
-  PM 5*16
-  PM 5*35
-  PM 5*40
-  PM 5*45

FOR BASIC CUT IN SIGNMASTER

1. Import the design in Signmaster. Follow the basic cut guide video for the mycut mini.
2. Feed the material into the plotter and make sure it is aligned and flat.
3. There are two ways to connect the plotter: USB and U-Disk. Choose one way to connect and follow the steps below.

Cutting via USB cable:

1. Connect the plotter and computer with USB cable.
2. In Signmaster, click "Vinyl Spooler" and choose "Direct COM port" in connection and click "Auto Detect" to recognize the plotter.
3. When the connection is successful, you can send the design to the plotter from Signmaster.

Cutting via U-Disk:

1. In Signmaster, click "Vinyl Spooler", choose "Windows Port" in connection and choose "File" in port.
2. Save the plt. file and put it in the U-Disk.
3. Insert the U-Disc into the plotter. Press "U-Disc," then choose the right plt. file to cut.

Cutting via network cable:

1. Connect the plotter and router or computer with network cable.
2. Import design to Signmaster, choose "Windows Port" in connection and choose "TCP" in port.
3. Click "Configure" and confirm the IP address. The computer's IP address must be the same as the plotter's IP address, and the value of the port must be 5000. (You can check the plotter's IP in the "Menu" option)
4. Click "Test". If the connection is successful, you can send your designs to the plotter from Signmaster.

Note: Your router's IP address can not be the same as the plotter's IP address. If they are the same, change the last number of the plotter's IP address in the "Menu" option.



THINK BEYOND

www.ricoma.com



facebook.com/ricomahq



youtube.com/ricomamiami



pinterest.com/ricomahq



instagram.com/ricomahq



twitter.com/ricomahq

Ricoma Headquarters in USA

Ricoma International Corporation

11555 NW 124 Street, Miami, FL 33178, USA

TEL: (305) 418-4421 | FAX: (305) 418-5036

Toll Free: 1-888-292-6282

Website: www.ricoma.com | Email: info@ricoma.com

Ricoma Factory in China

Ricoma (Huizhou) Co., Ltd

Ricoma Science & Technology Industrial Park, No.1 Hongtong Road,
Dayawan West District, Huizhou City, Guangdong, China 516083

Tel: +86-752-5366 999

Website: www.ricoma.cn | E-mail: info@ricoma.cn