

# QUICK START GUIDE: MT-1502 MULTI-HEAD



## **RICOMA INTERNATIONAL CORPORATION**

3450 NW 114th Ave., Miami, FL 33178  
Telephone: (305) 418-4421 | Toll Free: 1-888-292-6282  
Fax: (305) 418-5036 | Email: [service@ricoma.us](mailto:service@ricoma.us)  
[www.ricoma.us](http://www.ricoma.us)

# TABLE OF CONTENTS

<b>LEVELING THE MACHINE</b> .....	<b>06</b>
<b>POWER CORD CONNECTION</b> .....	<b>07</b>
<b>SECURITY LOCK</b> .....	<b>07</b>
<b>THREAD RACK, PANEL AND EMERGENCY STOP</b> .....	<b>08</b>
Raising the thread rack .....	08
Adjusting the position of the panel.....	08
Emergency stop button.....	09
<b>THREADING</b> .....	<b>09</b>
Initial threading .....	09
How to replace a spool.....	11
Threading sequence.....	12
Knot tying.....	15
<b>THREAD BREAK TROUBLESHOOTING</b> .....	<b>15</b>
<b>ADJUSTING THE TIMING OF A NEEDLE AND HOOK</b> .....	<b>16</b>
<b>REASONS WHY THREAD BREAKS OCCUR</b> .....	<b>16</b>
The garment or fabric.....	16
The embroidery design.....	17
Thread break prevention.....	17
<b>NEEDLES</b> .....	<b>17</b>
Anatomy of the needle .....	17
How long do needles last?.....	18
How do I know when to change a needle?.....	18
Why do needles break?.....	18
Changing a needle.....	18
Selecting a needle .....	19
<b>BLADE SIZES</b> .....	<b>20</b>
Size 75/11.....	20
Size 70/10.....	20
Size 65/9 or 60/8.....	20
Size 80/12.....	20
Size 90/14.....	20
Needle finishes.....	20
Types of needlepoints.....	21
<b>THE RELATIONSHIP BETWEEN NEEDLE AND THREAD</b> .....	<b>22</b>
<b>THE BOBBIN</b> .....	<b>22</b>
Spun.....	23
Filament.....	23
Magna glide bobbins.....	23
<b>INSERTING THE BOBBIN</b> .....	<b>24</b>
<b>TENSION</b> .....	<b>25</b>

Spring lever.....	25
Bobbin tension.....	26
Adjusting the bobbin tension.....	26
Adjusting the top thread tension.....	27
<b>BOBBIN FIBER CHOICES.....</b>	<b>29</b>
Cotton.....	29
Nylon.....	29
Continuous filament polyester.....	29
Spun polyester.....	29
<b>TOP THREAD.....</b>	<b>30</b>
Fiber choices.....	30
Rayon thread.....	30
Polyester thread.....	30
Metallic thread.....	31
Cotton thread.....	31
Thread consumption.....	32
<b>BACKING.....</b>	<b>32</b>
Cut-away.....	33
Tear-away.....	34
Specialty backings.....	34
Topping.....	34
Foam.....	34
Poly mesh backing.....	34
Fusible backing.....	35
<b>BACKING AND NEEDLE RECOMMENDATIONS.....</b>	<b>35</b>
Canvas.....	35
Canton fleece.....	35
Coated or waterproof fabrics.....	35
Corduroy.....	35
Cotton sheeting.....	35
Denim.....	35
Dress shirt (woven).....	36
Golf shirt.....	36
Headwear.....	36
Leather and vinyl.....	36
Lingerie or silk.....	36
Lycra or spandex.....	36
Nylon windbreaker.....	36
Satin jacket.....	36
Sweater knit.....	37

# TABLE OF CONTENTS

Sweatshirt.....	37
T-shirt.....	37
Terry cloth.....	37
<b>HOOPS AND BRACKETS.....</b>	<b>37</b>
<b>HOW TO ATTACH THE FLAT FRAME BRACKETS.....</b>	<b>38</b>
<b>HOW TO REMOVE THE FLAT FRAME BRACKETS.....</b>	<b>39</b>
<b>HOW TO INSERT THE HOOP INTO THE MACHINE.....</b>	<b>40</b>
<b>HOW TO REMOVE THE HOOP FROM THE MACHINE.....</b>	<b>40</b>
<b>HOW TO HOOP AND HOOPING RECOMMENDATIONS.....</b>	<b>41</b>
<b>HOOPING A POLO OR GOLF SHIRT.....</b>	<b>43</b>
<b>HOOPING A HOODIE OR JACKET.....</b>	<b>44</b>
<b>HOOPING PLACEMENT RECOMMENDATIONS.....</b>	<b>45</b>
Beach towels.....	45
Bath towels.....	45
Hand towels.....	45
Fingertip towels.....	45
Washcloths.....	45
Napkins.....	45
Pillowcases.....	45
Sheets.....	45
Robes – Men’s.....	45
Robes – Women’s.....	45
<b>HOOPING CAPS.....</b>	<b>46</b>
Hooping the front or sides of a cap.....	46
Hooping the back of the cap using a round hoop.....	47
<b>HOW TO INSTALL THE CAP DRIVER.....</b>	<b>48</b>
<b>HOW TO REMOVE THE CAP DRIVER.....</b>	<b>49</b>
<b>HOW TO INSTALL THE EXTENDED TABLE.....</b>	<b>49</b>
<b>ATTACHING THE SASH FRAME.....</b>	<b>51</b>
<b>OPERATING SPEEDS FOR FLATS AND CAPS.....</b>	<b>52</b>
<b>OPERATION PANEL AND KEY FUNCTION INTRODUCTION.....</b>	<b>53</b>
<b>NETWORK CONNECTION.....</b>	<b>55</b>
<b>HOW TO UPLOAD A DESIGN.....</b>	<b>55</b>
<b>DELETING A DESIGN FROM THE MACHINE’S MEMORY.....</b>	<b>56</b>
<b>EXPORTING A DESIGN FROM THE MACHINE’S MEMORY.....</b>	<b>57</b>
<b>EMBROIDERY STATUS SWITCHING.....</b>	<b>57</b>
<b>DESIGN SET PARAMETERS.....</b>	<b>59</b>
<b>PARAMETER RANGES AND FUNCTIONS.....</b>	<b>59</b>
<b>SELECTING THE PRESET HOOPS ON YOUR MACHINE.....</b>	<b>62</b>
<b>TRACING THE EMBROIDERY AREA.....</b>	<b>63</b>

<b>CONTOURED TRACING</b> .....	<b>63</b>
<b>EMBROIDERY PARAMETERS</b> .....	<b>63</b>
<b>COMPREHENSIVE MENU SETTINGS</b> .....	<b>63</b>
<b>RETURN TO ORIGIN (STARTING POINT)</b> .....	<b>64</b>
<b>FRAME OFFSET HOOP OPERATION</b> .....	<b>64</b>
<b>GO TO ENDPOINT</b> .....	<b>64</b>
<b>NEEDLE SWITCH DISPLAY/WORKING NEEDLE</b> .....	<b>64</b>
<b>SET COLOR SEQUENCE</b> .....	<b>65</b>
<b>SET COLOR CHANGING SEQUENCES</b> .....	<b>65</b>
<b>APPLIQUE OFFSET, LOW SPEED EMBROIDERING AND NEEDLE BAR PLACEMENT</b> .....	<b>66</b>
<b>CHANGE WORKING MODE</b> .....	<b>67</b>
<b>EMBROIDERING MODE SWITCHING– FLOATING MODE</b> .....	<b>67</b>
<b>OPERATION OF RETURNING TO EMBROIDERING POINT IN POWER FAILURE</b> .....	<b>68</b>
<b>EMBROIDERY RUNNING SPEED STATUS</b> .....	<b>69</b>
<b>ON-BOARD LETTERING</b> .....	<b>69</b>
<b>MANUAL TRIMMING</b> .....	<b>71</b>
<b>START AND STOP EMBROIDERING</b> .....	<b>71</b>
<b>MACHINE HEAD INDICATOR LIGHTS</b> .....	<b>71</b>
<b>HOW TO REWIND YOUR DESIGN</b> .....	<b>72</b>
<b>EMBROIDERY PROCESS FROM START TO FINISH</b> .....	<b>72</b>
1. Exit work status.....	72
2. Select a design.....	72
3. Select a hoop.....	73
4. Select the color sequence.....	73
5. Trace your design.....	74
6. Press start.....	74
<b>CAP OPERATION</b> .....	<b>74</b>
<b>CAP SELECTION</b> .....	<b>75</b>
<b>CAP FRAMING</b> .....	<b>75</b>
<b>CAP SEWING TECHNIQUES</b> .....	<b>75</b>
<b>CAP PROGRAMMING</b> .....	<b>76</b>
<b>LUBRICATION</b> .....	<b>76</b>
<b>CARE OF THE BOBBIN CASE</b> .....	<b>79</b>
<b>COMMON ERRORS</b> .....	<b>79</b>
Emergency stop error.....	79
Needle error / color change error.....	80
Main axis error.....	80
Resolving a thread break.....	81
Bobbin runs out.....	81

# LEVELING THE MACHINE

Leveling your embroidery machine is essential, as this step will ensure your machine is secured into place. Skipping this step may result in injury, loss of registration of your design, movement of the machine while sewing, and other issues.

Before leveling your machine, make sure the four level pegs are attached to the stand legs. You will find these pegs inside your accessory box. See Figure 1.

To attach the level pegs, insert the holding screws on each of the stand legs, and rotate each screw clockwise. Then, secure the hex nut using the black wrench included in your toolkit.

To level your machine, take all four level pegs on your machine stand and rotate them counterclockwise by hand until they reach the floor. Once the pegs have reached the floor, rotate each nut clockwise using the provided wrench. Do NOT skip this important step, as this will to ensure the pegs are fixed to the ground.

Once you have tightened all four pegs, the wheels on the machine's stand will lift, immobilizing the stand. Last, confirm the stand is secure. If it is no longer able to move with the wheels, you have correctly completed this step. See Figure 2.



Figure 1



Figure 2

## TURNING ON YOUR MACHINE -POWER CORD CONNECTION

The power socket is located on the right side of the machine's body. Connect your power cord into the socket displayed in Figure 3. Then, plug the power cord into a power outlet.

We highly recommend using a power supply (surge protector) rather than connecting the cord directly into the wall.

The power switch can be found above the power socket. The switch displays a circle (O) and a line (-). (O) indicates the machine is off and (-) indicates the machine is on.

The Ethernet cable socket is located to the left of the power cord connection. See Figure 3.



Figure 3

Ethernet cable

## SECURITY LOCK

Your Ricoma MT-1502 may have a security lock in between the machine heads. Before operating your machine, be sure to remove this lock. See Figure 4.

To locate the security lock, remove the metal cover displayed in Figure 5. The cover is attached to two magnetic locks. To remove the cover, simply slide it off. To remove the security lock, loosen its screws using an Allen wrench. You will find a set of Allen wrenches in your toolkit. Once the security lock is removed, return the metal cover to its original position.

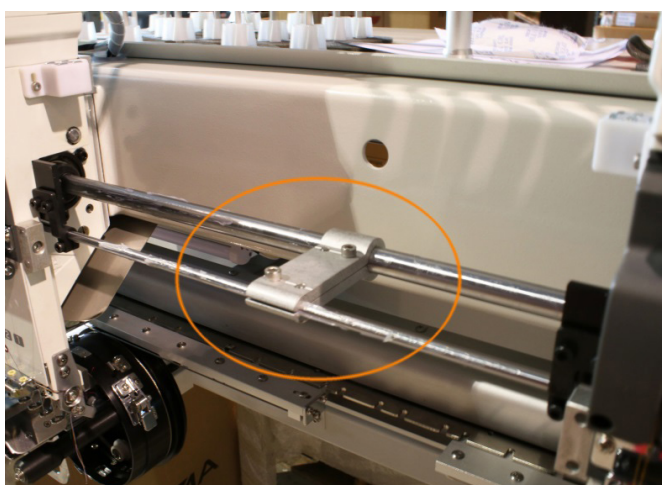

Figure 4



Figure 5

# THREAD RACK, PANEL AND EMERGENCY STOP

## Raising the thread rack

Before threading your machine, you must first raise the thread rack. See Figure 6. To do so, locate the knob on each side of the thread rack support. See Figure 7. Rotate each knob counterclockwise to loosen them. Now, lift the thread rack as far up as possible, making sure both sides of the rack remain even as it rises. Last, rotate each knob clockwise to secure the rack into place.

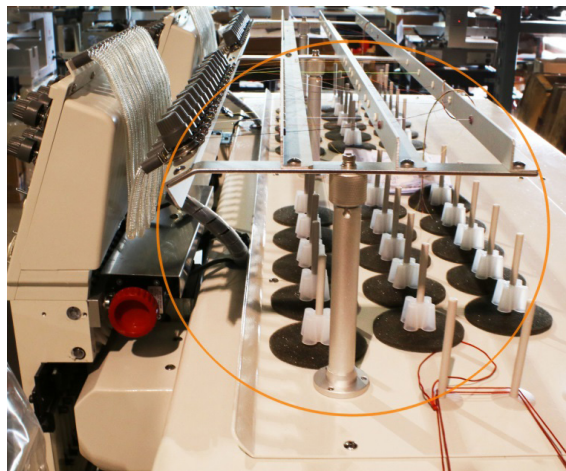

Figure 6



Figure 7

### **TIP:**

*If possible, raise the thread rack on both sides while adjusting it. This will ensure it is positioned evenly.*

## Adjusting the position of the panel

First, be sure to remove the plastic wrap that protects the panel. After removing it, you will find two Phillip screws, which will allow you to adjust the placement of the panel. Your touch-screen panel can be adjusted in two ways: up and down or from side to side. To adjust the panel, use the Phillip screw driver included in your tool box.

To move the panel from side to side, loosen the screw with the adjustment path located on top of the panel arm. See Figure 8. Then, adjust the panel assembly until it's facing the desired position. Next, tighten the screw.

To move the panel up or down, loosen the screw with the adjustment path located on the side of the panel arm. See Figure 8. Next, adjust the panel assembly until it's facing the desired position. Last, tighten the screw.



Figure 8

### **KEEP IN MIND:**

*This step is important, as you need to position the panel away from the machine head in order to avoid the head hitting the panel when it moves to the far right.*

## Emergency stop button

In case of an emergency, press the emergency stop button located on top right side of the panel. Then, rotate the knob clockwise following its directional arrows. The knob will then release, and the machine will stop.



Figure 9

## THREADING

### Initial threading

The thread tubes will be used during the threading process. See Figure 10. These tubes will carry the thread from the thread rack to the machine's head. Before threading your machine, make sure these tubes are in place. Attach one end of the tube to the slot just below the top thread tension knob. Attach the other end of the tube to the slot on the machine's head.

You may find it easiest to work from the center out. Guide yourself by counting the slots on the top and bottom to make sure you are attaching the tubes to their corresponding slots. The first slot on the top should go with the first slot on the bottom and so forth. Refer to Figure 11.



Figure 10

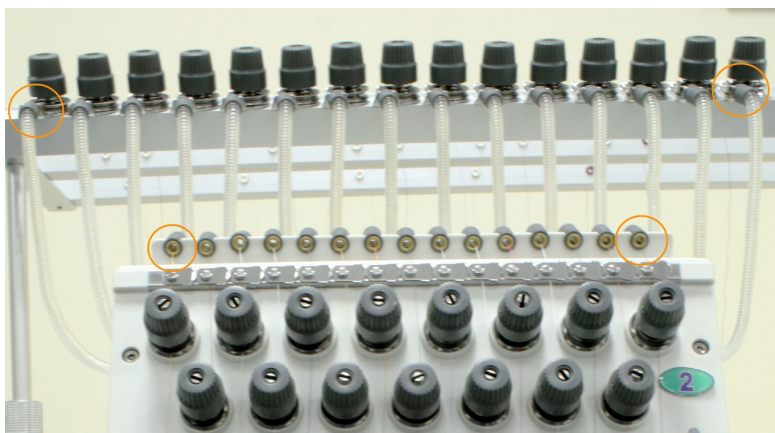

Figure 11

Your welcome kit contains two boxes of embroidery thread. You will need 15 spools of thread for each of the machine's heads. See Figure 12.

If you haven't done so yet, remove the wrappers on the provided thread spools.



Figure 12

To release the tail of the thread, unsnap the base of the cone, and unwind until the thread is completely out of the base.

Before positioning the spools, refer to Figure 13 to view which thread spool pin corresponds with each needle.

To begin threading your machine, snap each thread spool onto the spool pins. The spool pins are the 15 pins secured with grey foam and a clear plastic reel behind each of the machine heads. Do not get confused with the 3 pins on each of the far ends, which are for storing bobbin thread for easy reach when you are replacing your bobbin. See Figure 14.

Before threading, you should be familiar with the thread path. The back row of thread will be threaded through the back metal rack. The middle row of threads will be threaded through the middle metal rack. And the front row of threads will be threaded through the front metal rack. See Figure 15-A and 15-B.

**TIP:** It is best practice to allow enough room to walk behind your machine. That way, you can place the colors that you will use the most on the front row. This will allow you to tie new threads to old threads on the back rows while the machine is running.



Figure 13



Figure 14



Figure 15-A



Figure 15-B

## How to replace a spool

Because your machine comes pre-threaded, you will only need to replace the spools at first rather than threading the machine from the very beginning.

To do so, clip the thread from the existing thread spool. Make sure you clip the thread right above the spool and not inside the thread path. See Figure 16.



Figure 16

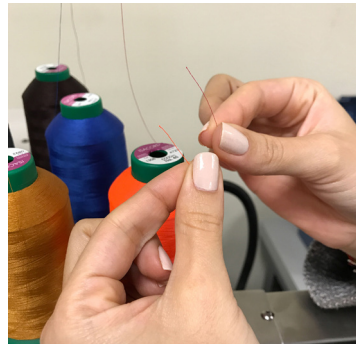

Figure 17

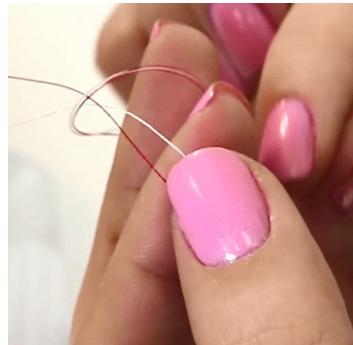

Figure 18

Now, go to the front of your machine and unravel the thread that's wrapped to each of the wheels on both sides of the machine head. Once you unravel it, make sure the threads are separated and hanging individually.

Next, grab the thread from the presser foot, and pull each thread all the way through until you no longer see any of the old thread. See Figure 19. While you pull the thread, you'll see the new thread and the knot you created traveling through the thread path.

Continue to pull until you see the knot you created reaches past the needle bar. Now, clip the thread right above the knot, and repeat the process on all remaining needles.

Once you have completed all needles, it's time to thread the needle. Pass the thread through the eye of the needle starting from the front to the back. Once your thread has gone through the needle, pass the thread down the presser foot. Now, you can rest your thread on the spring as shown in Figure 20. You should leave about two inches of thread hanging and trim the excess.

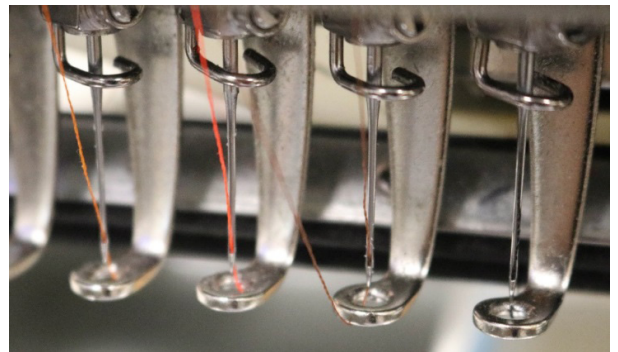

Figure 19

**KEEP IN MIND:** The color spools will need to be placed in the same order on both heads. For example, if you place the white thread on needle 1 on one head, you need to place the white thread on needle 1 on the remaining head as well.



Figure 20

## Threading sequence

To thread your machine from the very beginning, follow these simple steps. You will use the eyelets on the thread rack to guide the thread in a straight path toward the first tension knob. Make sure the thread passes through each eyelet.

See Figure 21.

You will need to thread the first three cones in order from back to front. Then, repeat this order with the next three cones and so forth.



Figure 21

**TIP:** If possible, try not to place colors that are similar, such as black and navy blue, close to each other. This could lead to accidental misuse of similar color.

1. Thread each spool through the eyelets on the upper thread rack until they reach the top tension knobs. See Figure 22.
2. Next, pass the thread through the small eyelet located behind the first tension knob. Position the thread to the right side of the top tension knob in between the tension disks, making sure the thread is inside the tab at the 3 o'clock position. To ensure you've completed this step correctly, make sure the metal plates on the tension knob are touching after you've positioned the thread. See Figure 23



Figure 22

Incorrect



Correct

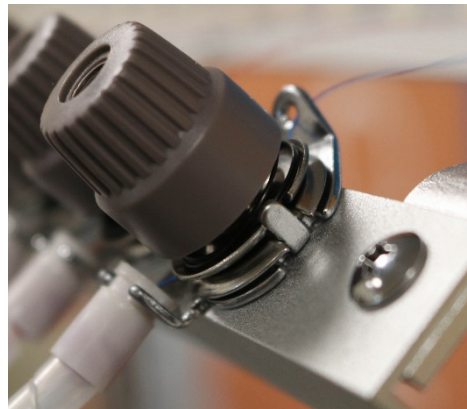

Figure 23

3. Unhook the thread tube from each side. Next, using the included threading tool from your toolkit, hook the thread to the end of the tool and feed the thread through the plastic tube. Once the thread has been fed through the tube, unhook the thread. See Figure 24 and 25.

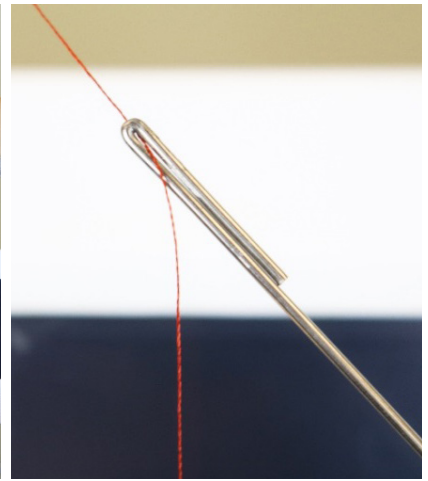

Figure 24 and 25

4. Reattach the thread tube to each end.

5. Pass the thread through the clip located just above the top tension knobs. Be sure to gently pull the clip up with your finger, rather than just sliding the thread under the clip to avoid damaging the thread and threading the machine incorrectly. See point A in Figure 26-A.

6. Next, pull the front disk of the tension knob toward you, and slip the thread to the right side of the knob. See point B in Figure 26-A. You will know which path to follow for each needle by using the numbers as guides. The photo displays the thread path for needle six. Notice the tension knob is aligned just above the number "6."

7. Locate the post right above the corresponding thread break wheel (these are the white wheels on the machine's head.) Pass the thread through the left side of the post as displayed in point C in Figure 26-A. Then, guide the thread to the right and wrap it under the thread break wheel. See the path from point C to E in Figure 26-A. Make sure you make one full clockwise rotation until the thread exits through the left side of the bottom post. See Point E in Figure 26-A.

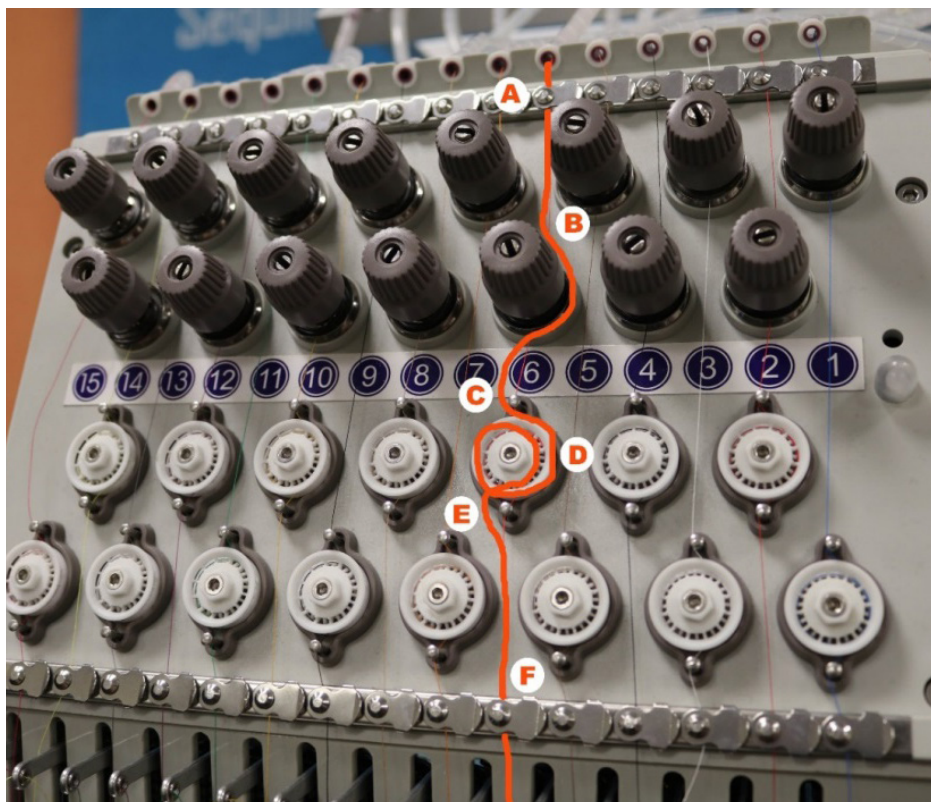

8. Place the thread under the bottom clip by pulling the clip up. Slide the thread underneath. See point F in Figure 26-A.

**TIP:** If you run out of thread completely on a needle bar, re-thread, matching the thread path to a correctly threaded neighboring needle bar.

Figure 26-A

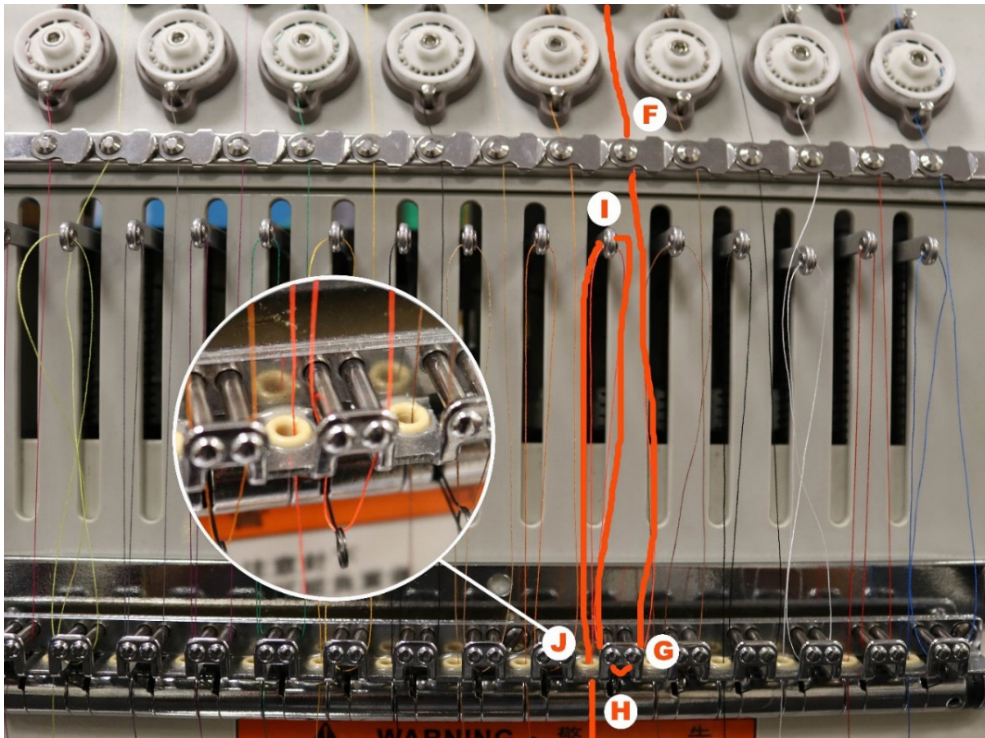

Figure 26-A



Figure 27

9. Next, you will thread the check spring and the lever arm. Begin by lifting the lever to place the check spring into threading position. Now, coming down from the right side, pass the thread over the outer right side of the rollers and then in through the opening in the center. See point G in Figure 26-B. Next, pass the thread through the spring from the right to the left. See point J in Figure 26-B. Then, take the thread and pull it through the opening in the center and out over the outer left side of the rollers. Follow the path from point G to I in Figure 26-B to complete this step.
10. Now, pull the thread up toward the lever arm and pass the thread through the opening of the lever arm from the right to the left as seen in point I in Figure 26-B. Then pass the thread back down until it runs through the ceramic eyelet pictured in point J in Figure 26-B and 27. Continue running the thread down the same path until it passes through the following ceramic eyelet as pictured in point K in Figure 27. Then, place the thread behind the thread guide near the top of the needle as seen in point L in Figure 27. You will need a bit of practice to do this quickly, but don't skip this important guide, which keeps the thread straight as it feeds through the needle
11. Pass the thread through the eye of the needle from the front to the back. To ensure your needle is placed correctly, make sure the curved side is facing the back. Then, pass the thread through the presser foot. See point M in Figure 27. Now, you can pull the thread back up to rest your thread on the spring until you're ready to embroider. We recommend leaving one to two inches of thread hanging and trimming the excess. This is optional, but will eliminate the need to snip the thread tail that will remain after the first stitch is made while the thread tail is still held on the wire.
12. Last, take a step back and look at the front of the machine to make sure that all needles appear to be threaded correctly. If they seem to be uniform, you are ready to stitch a test pattern.

## Knot tying

Mastering basic knot tying will save you time and materials. When tying new threads to old threads while replacing a spool, you want to create a knot that will pull easily through the needle's eye. See Figure 28.

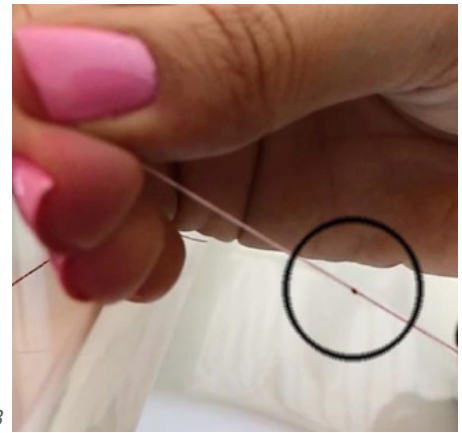

Figure 28

## THREAD BREAK TROUBLESHOOTING

There are a number of reasons why you may be experiencing recurring thread breaks. To ensure it is not a technical issue, follow these steps.

1. Check the thread path to make sure your machine is threaded correctly. It should be following the correct path detailed in the Threading section of this guide.
2. Make sure your thread tension is correct. Tight tension may lead to missed stitches, thread breaks, pulling, puckering and thread stress. Loose tension will cause thread to pile up and loop.
3. Inspect the needle position to determine if an actual thread break has occurred. Sometimes your machine may read a thread break, but the thread will still be attached to the fabric. If this is the case, check all the thread paths. Then, do a manual trim and check the bobbin supply. If the thread is broken, follow the correct thread path and rethread the needle.
4. Make sure the thread you're using is not defective. If so, pull out a few yards of thread until you've gotten rid of the defective thread. If that doesn't work, try replacing the thread with a new cone.
5. Check for defective needles or needles not inserted properly. You will be able to tell if a needle is defective or not positioned correctly by verifying if the problem is on one or some needles and not others. Replace any damage or bent needles.
6. Make sure the bobbin is installed properly. Remove any lint or dirt build-up in the bobbin case. Make sure the thread trimmer knife is fully retracted.
7. If thread breaks are occurring on all the needles, you need to adjust the hook timing. Refer to Adjusting the timing of a needle and hook for details.

# NEEDLE AND HOOK TIMING

The timing of the needle is set up to 200 degrees and the relationship between the needle and the hook is as follows. The proper space between the needle and the hook should be 0.1 mm to 0.3 mm. See Figure 30.

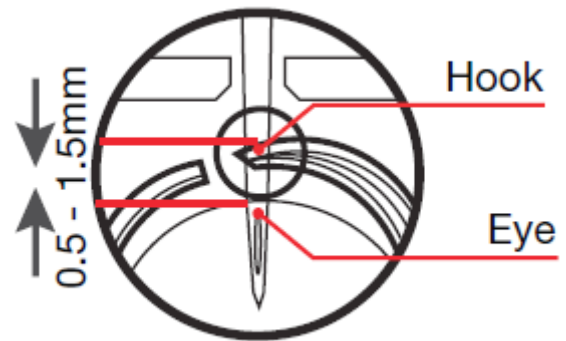

Figure 29

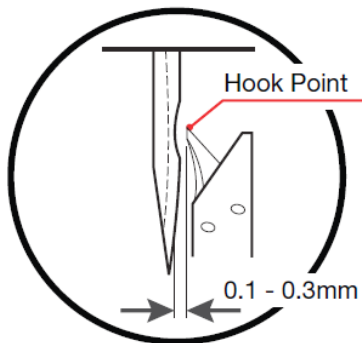

Figure 30

**TIP:** If the space between the needle and the hook point is out of range, the thread will not catch. This will cause thread breaks. If the space between the needle and hook point is too close, it will cause broken needles.

## REASONS WHY THREAD BREAKS OCCUR

### The garment or fabric

1. **Thick fabric:** If the fabric is too thick, needles will tend to bend slightly as thread passes through. This causes the thread to scrape against the needle plate, shredding the thread. To correct this issue, replace the existing needle with a larger needle.
2. **Hidden obstructions in the garment:** Obstructions such as bulky seams, inside pockets and hidden buttons may cause thread breaks.
3. **Improper hooping:** Make sure the item is hooped properly. Loosely hooped fabric will bounce up and down during sewing.
4. **Excessive backing:** Excessive backing results in thread and needle breaks, as it applies greater friction to the thread and needle.

## The embroidery design

1. **Very high thread density:** Designs with high thread densities may cause needle deflection, which leads to thread shredding and thread breaks. Too many stitches in a small area may also cause thread breaks. Try deleting short stitches or increasing the design by 5 to 10 percent.
2. **Extremely short stitch lengths:** Short stitch lengths may cause thread to pile up in one area. Also called “nesting,” this issue may result in thread shredding and thread breaks.

## Thread break prevention

1. Proper thread care is necessary to prevent thread breaks. We recommend storing thread in a dark, cool place. Old threads that have not been stored properly will cause thread breaks. Prolonged exposure to air, light, age and heat will cause threads to become brittle. If this occurs, replace the old thread and store the new thread in a dark, cool place.
2. Do NOT use tape to tie off thread ends. Tape leaves a sticky residue that causes friction and thread breaks.
3. Check for burrs in the thread guides, needle eye, thread plate and hook.

# NEEDLES

## Anatomy of the needle

1. **Shank:** The top section of the needle that attaches to the needle bar (into the machine).
2. **Shaft/Blade/Shank:** The part of the needle that ranges from the end of the shank to the top point of the needle.
3. **Taper:** The narrowed end of the needle that lies below the eye.
4. **Point:** The very bottom of the needle. The part of the needle that pierces through the fabric.
5. **Eye:** The opening where the thread passes through the needle.
6. **Groove/Thread Groove/Front Groove:** The indented surface that runs along the face (front) of the needle.
7. **Scarf:** The half-moon-shaped cut out on the back of the needle, located just above the eye.

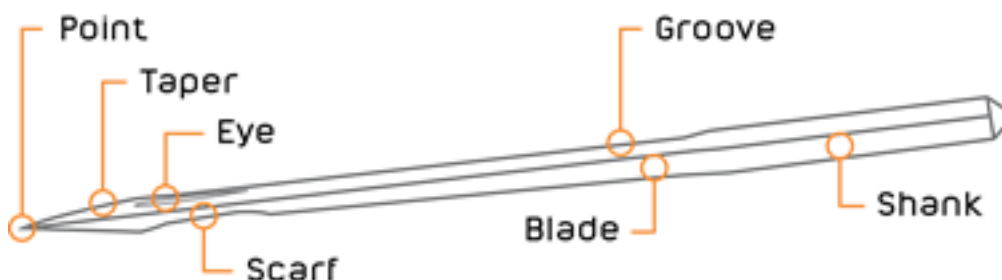

Figure 31

## How long do needles last?

There are several factors that determine the lifetime of a needle.

This includes but is not limited to:

- The material the needle is made of
- The style of the needle
- The material you are sewing on
- How often you use the needle

## How do I know when to change a needle?

Several performance changes in your machine will indicate when it's time to change a needle. This includes but is not limited to:

- Thread breaks
- Poor stitch quality
- Pulls in the fabric
- Machine making unusual noises
- Machine operating at reduced speeds

## Why do needles break?

Needles break for a number of reasons. This includes but is not limited to:

- The needle being worn out or old.
- The design having too many stitches and/or too high density for the design area.
- The fabric inside the hoop area being too loose (the material is not hooped tight enough)
- The needle hitting the hoop.
- The movement of fabric while the needle is penetrating.

## Changing a needle

A basic guideline that many professional embroiderers use to determine when to change needles is the “three strikes” rule. When there have been three consecutive thread breaks on a needle, it should be changed.

When changing a needle, ensure the scarf of the needle always faces the BACK of the machine. If the needle is not positioned correctly, the machine will not work properly, and the needle will break.

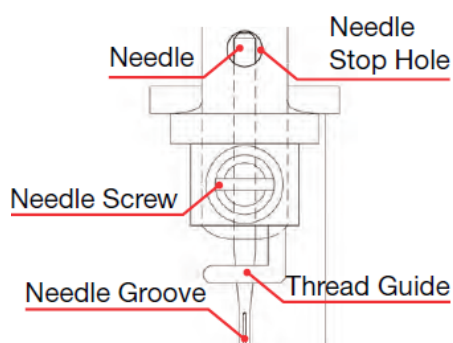

Figure 32

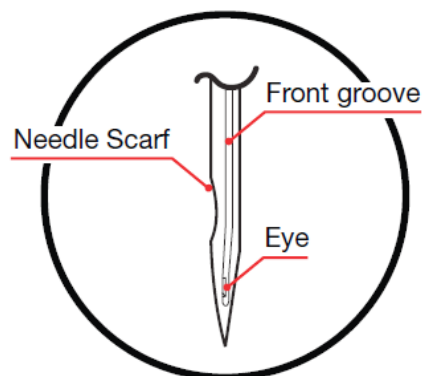

Figure 33

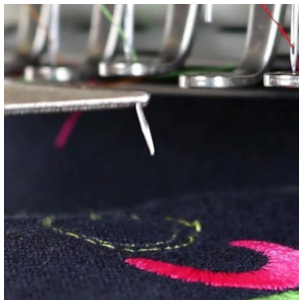

Figure 34



Figure 35



Figure 36

### **TIP: CHANGING NEEDLES**

*When changing the needle, set the needle aside while you determine whether a fresh needle corrects the problem. If you determine that the needle was the likely cause of the problem, discard in an old medicine bottle or other sharp-safe container.*

1. Begin by removing the broken needle excess from the garment. If it is not on the garment, check the bobbin area. See Figure 34.
2. Proceed by loosening the set screw above the needle with a straight slot screwdriver. Loosen only enough to remove the screw.
3. Discard the spent needle in a childproof pill bottle or other sharp-safe container.
4. Needles have a long groove on the front and a short half-moon-shaped section called the scarf on the rear. With the long groove facing the front of the machine, insert the new needle by placing the point through the presser foot, and then inserting the shank into the needle bar until it can be inserted no further. See Figure 35.
5. Verify that the long groove of the needle is still facing forward. Tighten the needle screw while holding the needle firmly to keep it from slipping down. See Figure 36. If necessary, hold the needle with a wooden toothpick inserted into the eye. Never place a metal object in the needle's eye, as it could scratch the eye of the needle, causing thread breaks.

## Selecting a needle

Choosing the right needle is important to ensure quality stitches. Embroidering with a needle that is too small or too big for the thread and/or fabric may result in thread breaks or skipped stitches. There are three things to consider when choosing the right needle for the job: finish, size and point.

DBxK5 is an established standard system for machine embroidery. This style needle has a medium point with a larger eye, which allows the thread to flow smoothly and helps reduce thread breaks. Its only downfall is that it is slightly less durable due to its thinner eye wall. For stretch materials, use ballpoints. For cottons, use sharp-points.

DBx7ST is ideal for metallic threads. It has an extremely large rectangular eye that allows for easy passage of thread. You may also use size 80/12 needles for metallic threads.

# BLADE SIZES

One of the first things to consider when selecting a needle is the blade size, such as size 75/11 or 90/14. If you have ever wondered why there are two numbers in this designation, the reason is that it is a combination of the European and American size designation numbering systems. The first number, such as 75 or 90, is the European designation. This refers to the actual measurement of the blade diameter. For example, a size 80 needle has a .80 mm blade width. The second number, such as 11 or 14, is an Asian numbering system. In this system, a smaller number indicates a smaller blade diameter.

## Size 75/11

Good overall needle. It is used to sew everyday items like golf shirts, sweatshirts, dress shirts, light jackets, light canvas, aprons, holiday stockings and more.

## Size 70/10

Good needle for the newer tech garments. It is used to sew moisture management (wicking), anti-bacterial and body temperature management garments, such as t-shirts and golf shirts.

## Size 65/9 or 60/8

Good needle for very light or delicate materials. It is used to sew silks and fine linens. It is also used to sew detailed designs on small areas, such as intricate patches or very small lettering.

## Size 80/12

Good needle for heavy materials. It is used to sew heavy canvas, vinyl, light leather, ball caps, visors and more.

## Size 90/14

Good needle for metallic thread. It has a larger eye, which allows the thread to easily pass through the eye. Used to sew canvas and belts too since it is a very stiff needle.

**TIP:** *The point must be able to pierce through the fabric easily to avoid deflecting when the needle contacts the material. Otherwise, the needle will strike the surrounding metal or the needle plate, potentially causing damage to the needle or the machine. Choose a finer blade for more fine-woven or knit fabrics. Use a larger blade for tough fabrics that could cause needle deflection.*

## Needle finishes

Most sewing and embroidery needles have chromium plating that enhances durability and appearance. Titanium-coated needles are more expensive than chromium-plated needles, but they can last as much as five to seven times longer than their chromium-plated counterparts. These types of needles also reduce thread friction. Reduced thread friction lessens the frequency of thread breaks, and saves time and labor. Titanium needles are a beautiful golden color and are available in the most popular sizes.

## Types of needlepoints

In order for the needle to penetrate cleanly through the fabric, it is necessary to choose the correct point type. The types of needlepoints used for commercial embroidery include:

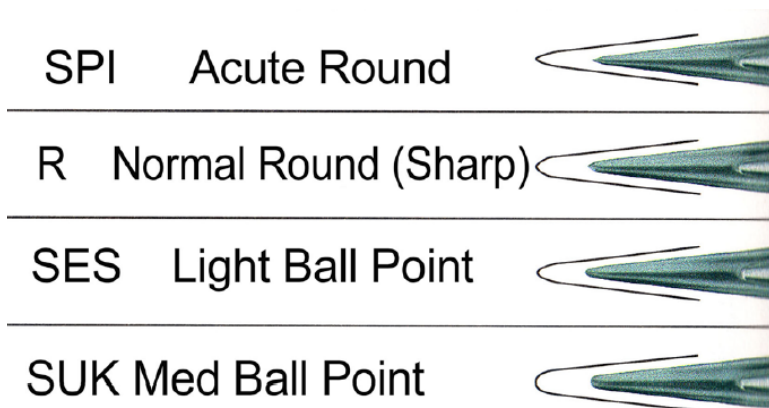

### 1. Acute Round Point – designation SPI

- Has a slender sharp point
- Used on fabric with high thread counts, microfibers and certain synthetics

### 2. Normal Round Point – designation R

- Has a normal sharp point
- Used on woven fabrics, including finished caps

### 3. Light Ball Point – designation SES

- Designed to spread yarn in knitted fabrics rather than piercing them to maintain the structural integrity of the knit
- This is the most popular needle type and is considered a universal point type
- Suitable for most knit and woven fabrics.

### 4. Medium Ball Point – designation SUK

- Used to spread heavier yarns such as those used in heavier knitted fabrics

Figure 37

THE TWO PRIMARY POINT TYPES USED FOR SEWING AND EMBROIDERY  
ARE SHARP-POINT AND BALLPOINT.

**Sharp-point** needles are used to sew woven materials. These needles will cut the material when they need to, but often find their way into the existing holes of the fabric, just like the ballpoint needles. Made on a loom, woven materials consist of many individual threads. This means: If one thread is broken, other threads will remain intact. Your machine comes shipped with sharp point needles.

**TIP:** We recommend using Groz-Beckert brand needles.

The designation for sharp-point Groz-Beckert needles is RG.

**Ballpoint** needles are used to sew knit materials. These needles are non-cutting and work by finding their way into the holes that already exist in the material. If you get holes on knit material, it will unravel due to the fact that knits are made of one continuous thread.

**TIP:** We recommend using Groz-Beckert brand needles.

The designation for ballpoint Groz-Beckert needles is FFG.

**TIP:** In order to puncture the smallest hole possible, always use the smallest needle you can get away with. Heavier materials cause the needle to bend, or deflect. This causes needle breaks, thread breaks, missed stitches and other issues. We control the needle deflection by slowing down the speed of the machine and/or changing the size of the needle.

# THE RELATION BETWEEN NEEDLE AND THREAD

The chart below displays which size needle corresponds with which size thread. For example, a 0.25 needle in the U.S. corresponds with size 70 cotton thread. See Figure 38.

Size of a Needle			Size of a Thread			
U.S.A.	Japan	Germany	Cotton	Silk	Nylon	Rayon
0.25	9	65	70~80	100~120	130~150	70~100
0.27	10	70				
0.29	11	75	50~60	80~100	100~130	100~130
0.32	12	80				
0.34	13	85	50~60	60~70	80~100	130~150
0.36	14	90				

Figure 38

## BOBBINS

When it performs well, we take the bobbin for granted. But when you have trouble with bobbin thread, it confounds all efforts toward efficient production. That's because the bobbin affects all needle bars. This makes it impossible to achieve better sewing by simply switching to another needle. Such a vital element commands closer examination.

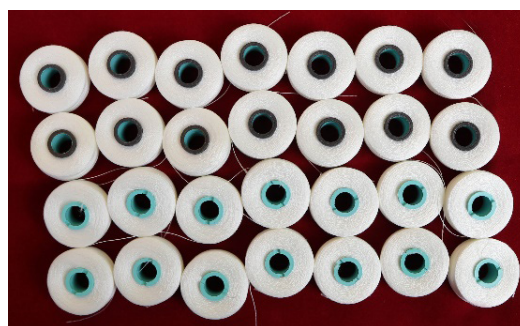

Figure 39

You have the choice of winding your own bobbins or buying pre-wound commercial bobbins in disposable cartridges. Self-wound bobbins tend to be inconsistent in the way the thread releases from the spool. For high-speed commercial embroidery machines to function properly, a smooth and consistent release of thread is required. Commercial pre-wound bobbins are a cost-effective and efficient solution to ensure bobbin thread runs smoothly.

On average, bobbin thread usually last for about 35,000 to 42,000 stitches depending on the stitch length of your design.

Your Ricoma machine requires an "L" size bobbin. Polyester bobbin thread is preferred over cotton bobbin thread, as it tends to leave less lint.

There are two different ways that polyester bobbins are created.

## Spun

In this process, small fibers are spun together to form the thread. We do NOT recommend using spun bobbins, as they have the tendency to shear off and collect under the tension spring of the bobbin case. This may cause tension issues over time.

## Filament

Under this process, the thread consists of one long filament.

Filament bobbin runs cleaner in the bobbin case and is significantly stronger.

There are three different types of bobbin sides.

- Paper-sided: These are the most common.
- Sideless: Consists entirely of thread and do not have sides for support.
- Plastic-sided: Some embroiderers say plastic-sided bobbins rotate more easily in the bobbin case and run smoother.

## Magna Glide bobbins

Magna Glide bobbins have a magnet in the center, which helps maintain the consistency of the bobbin thread tension. This can help the bobbin run smoother and prevent birdnesting. When using magnetic bobbins, you may need to take out the gunmetal-colored piece on the bobbin case, known as the brake.

## The anatomy of a bobbin case

Before threading the bobbin and inserting the bobbin into the machine, be familiar with the parts of the bobbin case that will be referenced. See Figure 40 below.

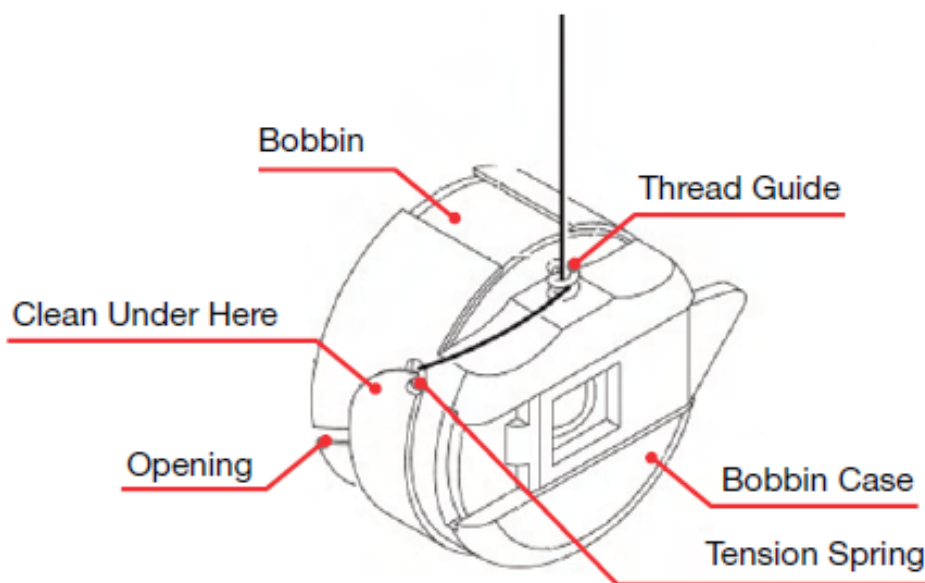

Figure 40

# INSERTING THE BOBBIN

1. If you haven't done so yet, remove the bobbin case from the machine's bobbin housing unit. To do so, simply lift the latch and pull the bobbin case toward you.
2. Pull out the empty or nearly empty bobbin and discard or rewind.
3. Insert the bobbin into the bobbin case, making sure the thread is running clockwise. See Figure 41.
4. Pass the thread through the bobbin case slit. See Figure 42.
5. Pull the bobbin thread under the tension arm, making sure the thread exits at the notch on the other end. See Figure 43.



Figure 41



Figure 42

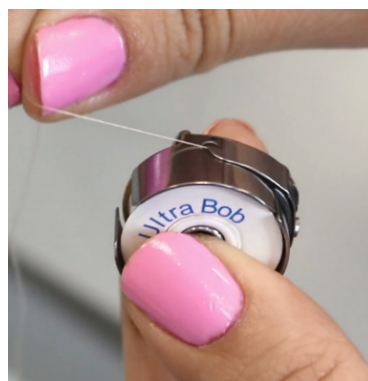

Figure 43

6. To ensure the bobbin is placed correctly, turn the bobbin case to the other side, and pull on the thread. The bobbin thread should still be running clockwise in this direction, and you should see the letters rotating clockwise. See Figure 44.
7. Wrap the thread around the small pigtail on the bobbin case. See Figure 45.
8. Grab the bobbin case while lifting the latch, and insert it into the machine. Make sure the thread tail is no longer than 3 inches. A longer tail can wrap around the shaft and create a build-up of thread. See Figure 46.

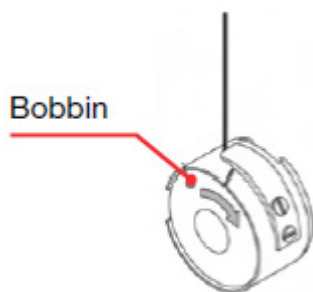

Figure 44

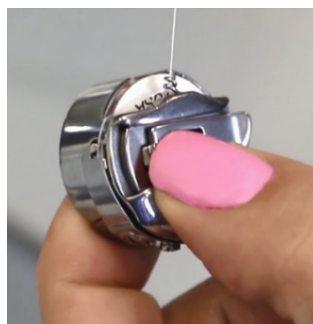

Figure 45



Figure 46

# TENSION

Proper thread tensioning is necessary for quality embroidery. Improper thread tension will cause a number of embroidery issues. For instance, tension that is too loose will cause threads to loop; and tension that is too tight may cause frequent thread breaks.

Tension will depend on the complexity of your design; the fabric, thread and backing you're using; and even hooping.

Before making any tension adjustments, make sure your machine is threaded correctly. Sometimes you may encounter tension issues simply because your machine is threaded improperly.

You can adjust the tension settings using the following:

- The spring lever
- The top tension knobs
- The bobbin case

If you've verified your machine is threaded correctly, start by adjusting the check spring lever. See Figure 48.

Please keep in mind: Before making any tension adjustments using other factors such as the bobbin case and the tension knobs, we recommend first adjusting the spring lever – as this is the quickest fix and small changes to the spring lever may regulate the tension on your design.

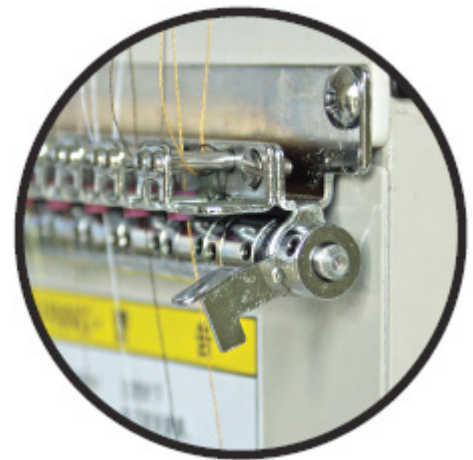

Figure 47

## Spring lever

The spring lever controls the tension of all the needles, while the tension knobs control the tension of the working needle.

We recommend maintaining the spring lever directly in the center, at a 90-degree angle. When adjusting thread tension, position the lever one or two clicks either up or down from the center. The spring lever's placement will vary depending on your material and design.

- When sewing heavy materials, place the spring lever lower.
- When sewing lightweight materials, place the spring lever higher.

You should never place the spring lever neither all the way up nor all the way down, as either scenario may result in thread breaks. If the spring lever is positioned all the way up, all of your needles' threads will be too loose to function properly.

Conversely, if the spring lever is positioned all the way down, all of your needles' threads will be way too tight to function properly.

If you want to tighten the tension of all the needles, you should place the spring lever one or two clicks below the center.

If you want to loosen the tension of the needles, you should place the spring lever one or two clicks above the center.

If you've tried moving the spring lever and you are still experiencing tension issues, move on to checking your top thread tension and bobbin thread tension.

## Bobbin tension

The tension on the bobbin case affects the stitching that comes from every needle bar. The most widely accepted tension test is the "I" test. This is conducted by sewing a one-inch tall satin column and examining the reverse side. The textbook bobbin tension setting that you are shooting for is shown in Figure 48: one-third bobbin thread running exactly down the center of the column, with one third top thread running down each side.

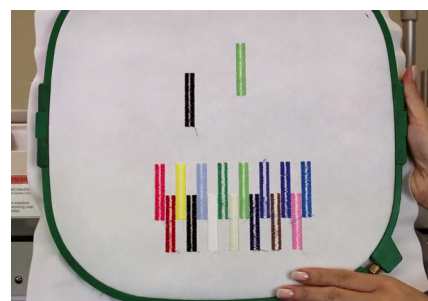

Figure 48

## Adjusting the bobbin tension

Proper bobbin tension is essential for quality embroidery. If tension is incorrect, you may begin to experience frequent thread breaks.

You can fine-tune the bobbin tension by adjusting the large screw on your bobbin case.

Rotate the screw counterclockwise to loosen the tension, or rotate the screw clockwise to tighten the tension.

When too much bobbin is showing on the back of your design, your bobbin tension is too loose. To resolve this, take your bobbin case and tighten it by rotating the large screw clockwise. This screw is labeled "Tension Adjusting Screw" in Figure 49.

When too much bobbin is showing, it also means your top tension is too tight and your top thread will appear smaller than your bobbin thread. You may need to slightly tighten the bobbin tension when stitching caps, thick materials or small details. See Figure 50.

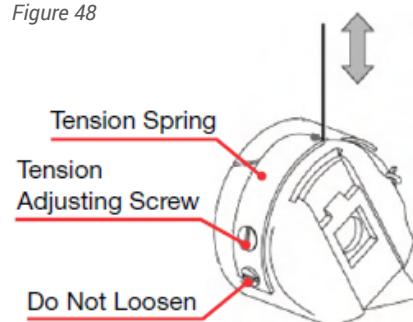

Figure 49



Figure 50

**TIP:** One tip-off that you need to adjust the bobbin case rather than the top tension knob is when similar symptoms are exhibited on all needle bars.

When too little bobbin is showing on the back of your design, your bobbin is too tight. To resolve this, you will need to loosen the bobbin case by rotating the large screw counterclockwise.

Bobbin tension that is too tight may result in a narrow column, or even a single strand of bobbin thread down the center of the satin column stitched during the “I” test. This can cause the embroidery to unravel easily if the bobbin thread ever gets snagged. See Figure 51.

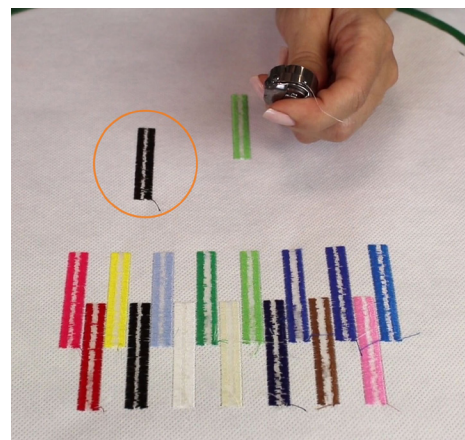

Figure 51

Even if the bobbin thread stays put underneath the embroidery, chances are, the columns will not have clean, crisp edges.

Erratic bobbin tension usually results from a catch in the bobbin case. For this reason, try pulling a few feet of bobbin thread to see if there is a point in the rotation of the bobbin in the case that is not smooth. This catch can be the result of an ill-fitting bobbin that has been overfilled or that has a manufacturing defect. If you suspect the bobbin is not rotating smoothly in the machine, check by placing the bobbin case face down on the machine table or a flat surface. Then, pull a few inches of thread out. If the bobbin isn't spinning freely on the surface, the odds are that it isn't spinning freely in the machine either. Retest the case with another bobbin.

If you are still experiencing bobbin tension issues after adjusting your bobbin thread, be sure that you are not using a damaged bobbin case, as this may cause undesirable results. Other factors can include improper top thread tensioning and damaged needles.

## Adjusting the top thread bobbin tension

The top tension knobs allow users to quickly adjust tension settings on a single needle. Before you start adjusting your tension knobs, check the bobbin thread tension. The top tension knob is pictured in Figure 52.

If too much top thread is showing on the back of your design, tighten the top tension by rotating the knob clockwise. If too little top thread is showing on the back of your design, loosen the top tension by rotating the knob counterclockwise. We always recommend starting with small quarter turns either to loosen or tighten the tension. That way, you get a better idea of how each tension adjustment affects your design and get to know your machine better.

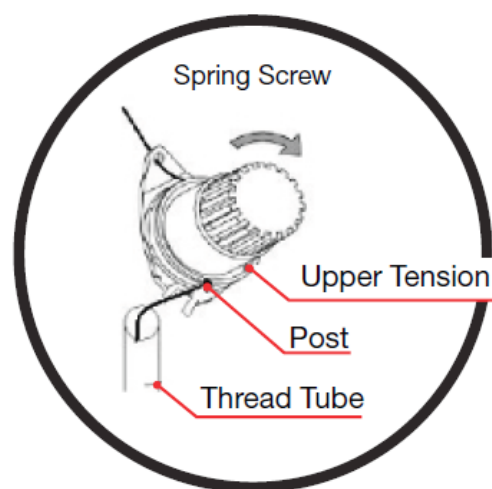

Figure 52

**TIP:** Experiment by making small adjustments until you feel comfortable with your design. Keep in mind: Every design is different and will require different tension settings.

The tension settings may vary by the thread's manufacturer. While most brands tend to be similar, the type of thread may have an effect on tension. For instance, polyester threads require nearly twice the amount of tension as rayon.

- Rayon thread tension should be from 100 to 120 grams.
- Polyester thread tension should be from 120 to 150 grams.

**TIP:** *When using a specialty thread, such as supertwist, lower the tension to prevent thread breaks.*

Depending on the type of thread you will use, you will need to adjust the tension knobs. For the best quality design, make the following tension adjustments when necessary.

- For metallic and polyester threads, rotate the tension knob one time counterclockwise.
- For light color rayon threads, rotate the tension knob one to two times counterclockwise.
- For white rayon thread, rotate the tension knob one time counterclockwise.
- For medium color rayon threads, rotate the tension knob one to two times counterclockwise.
- For dark color rayon threads, rotate the tension knob two to three times counterclockwise.
- For black rayon thread, rotate the tension knob three times counter clockwise.

**TIP:** *If your tension is correct and you continue to experience thread breaks, make sure your needle is fresh. Old needles may produce burrs and lead to frequent thread breaks.*

## Other factors that affect tension

- The color of the thread is a factor that affects thread tension because the dye affects the texture of the thread. The texture of the thread affects how smoothly it slides through the machine and the needle.
- Another factor that contributes to tension is the weight of the thread. If you change the weight of the thread, you will need to adjust the tension.
- The speed of the machine may also affect tension. The slower the speed of the machine, the better quality designs it will stitch.
- Excess dust and lint along the thread path may also affect the thread tension.

# BOBBIN FIBER CHOICES

## Cotton

This fiber isn't exactly a popular choice, but it definitely has its followers. Although not as strong as its synthetic counterparts, cotton is valued for its friendly texture, which allows a wider range of adjustments for bobbin tension settings. One of its downfalls is that it produces too much lint, which has a tendency to collect under the bobbin tension plate. Lint build-up can lead to "springing" the tension plate, causing it to fail to hold any tension on the bobbin thread.

## Nylon

Nylon bobbin thread exhibits almost exactly the opposite characteristics from cotton. One advantage of using nylon thread is that very fine nylon is still quite strong, so a bobbin can hold many yards of thin nylon thread. The cons of using nylon thread: Its small diameter and slick texture make it tricky to keep consistent tension on bobbin cases. It is also extremely slippery, which makes it difficult to maintain tension.

## Continuous filament polyester

This fiber is the most popular among U.S. embroiderers. It is strong, thin, reliable, and does not produce lint. It is known for its consistency and high quality. It also allows 127 yards to be held on a standard size "L" bobbin. For this reason, American embroiderers use this bobbin fiber more than any other. Fewer bobbin changes or breaks maintain efficiency because it allows for less machine downtime.

## Spun polyester

Spun polyester has a number of benefits that make it the number one bobbin fiber choice of many. Its texture is similar to cotton, without the lint problem. It is also the most economical. Spun polyester bobbins require less plate pressure. However, they leave a lint build up in the bobbin case, which needs to be removed and maintained. One reason that it has been overlooked is that many people mistakenly believe that a size "L" bobbin will hold only 94 yards of this thread. While that's true of size 100 spun polyester, several suppliers carry size 120 spun polyester. This size yields 120 yards per bobbin, only seven yards shy of continuous filament polyester.

# TOP THREAD FIBER CHOICES

Size 60, 70, and 80 threads are lightweight threads. This specialty thread is used on fine fabrics, small delicate details and small fonts. If you are using this type of thread, increase the density by 5 to 10 percent.

Size 30 and 40 threads are medium-weight threads. This specialty thread can be used to fill large embroideries with fewer stitches. If you are using this type of thread, decrease the stitch count by 15 percent. This will save production time. Weight 35 is commonly used for multi-color threads. Your welcome kit includes size 40 threads.

Size 12 threads are heavyweight threads. This specialty thread creates the look of hand embroidery. If you are using this type of thread, use long floating stitches. There is special set-up time required for this thread. We recommend adjusting the tension when using this type of thread.



Figure 53

## Rayon thread

Rayon thread is widely used by U.S. embroiderers. It is available in sizes 30, 40 and 60. Rayon is a very beautiful, supple and natural fiber made from cellulose. Its handling properties are superior to other fibers used for embroidery thread, and it looks very rich when sewn onto fabric. Unfortunately, it is not one of the stronger fibers. Even slight equipment problems may cause an unacceptable number of thread breaks when using rayon thread. Rayon is more expensive than other fibers and is susceptible to damage by environmental factors, such as temperature and light. Black and white Rayon threads tend to break more frequently because of the bleaching and dyeing processes. White is heavily bleached to reach its brilliant white color, and black is weakened by the amount of pigment it must absorb to obtain its rich black color.

**TIP:** Polyester thread is a great choice for towels and infant items that will be bleached.

## Polyester thread

Years ago, polyester embroidery thread was very hard to handle because this fiber is very stretchy by nature. This resulted in looping, which caused operators to tighten down on tensions. This compounded the problem because this stretched the polyester fiber even more. When the thread's memory caused it to regain its original length, the embroidery was often puckered. Today's polyesters are greatly improved and many have excellent sew-ability. The color ranges have also

improved, making it a good choice for embroiderers. It may be too strong for certain lightweight, delicate goods, but its resistance to thread breaks can add to production efficiency. We recommend 100% Polyester thread for all embroidery projects.

Polyester is one of the two embroidery fibers that can accept neon dyestuffs. The neon colors that you are using in your shop are very likely to be polyester fiber. With excellent resistance to abrasion and bleaching, polyester thread is a great choice for items that will be subjected to sunlight, chlorine or harsh laundering.

**TIP:** *Polyester is stiffer than rayon, and may require some tension or check spring adjustments. Experiment with different tension settings using the spring lever to make tension suitable for this type of thread.*

## Metallic thread

Avoided by many embroiderers, metallic threads are sometimes difficult to handle. The good news: This beautiful thread type can be tamed.

This thread is stiffer than other varieties, and it has an interesting construction. Metallic threads are actually a metallic film glued to a nylon or polyester core. The quality varies widely among manufacturers, so we recommend talking to other embroiderers to find a brand that performs well.

If you have experienced difficulty in sewing with metallic threads, try:

- Using a smaller size thread
- Using a needle with a larger eye
- Threading the metallic through the packing peanut attached to your thread rack.
- Checking your programming
- Making sure the densities are appropriate for metallic threads
- Checking if there are too many short stitch lengths, or small turning stitches



Figure 54

**TIP:** *Buy the best metallic brand on the largest spool you can afford. The larger diameter of the spool produces fewer kinks as it unwinds.*

## Cotton thread

For a home spun look, or when creating small personalization on dress shirts, cotton is ideal. Cotton thread makes it easy to adjust tensions. It also has a matte finish that is sometimes preferred over the shiny finish of other thread types. It is available in a broad range of sizes, from very large to very fine. At one time, it was the favored thread for detailed golf logos. Today, it is used for appliqués that are intended to have a homemade look.

## Thread consumption

Thread consumption varies according to the type of stitch being made. Longer stitch lengths, such as long satins or jump stitches, use more top thread than shorter stitch lengths like fill stitches. Using an average mix of stitch types, a 5,000-yard cone yields about 9 million stitches. If the cone costs \$9, this would be about one cent per thousand stitches. Bobbin thread yield is about 25,000 to 30,000 stitches for size “L” bobbins. The amount of yardage per bobbin varies according to the thread type.

## BACKING

Also known as stabilizer, backing is the foundation for good embroidery. Designed to support or even replace the fabric, it helps hold the fabric as flat as possible to prevent distortion of the embroidery design. There are different types of backing/stabilizer used in embroidery. The proper backing to use depends on the fabric you will be using.

There are three factors you need to consider when selecting backing:

- **Stability of fabric:** Stretchy or loose fabrics need a heavy backing. On the other hand, stable and tight woven fabrics need a light or medium backing.
- **Stitch density:** The higher the density, the heavier the backing should be.
- **Wash-ability:** If the fabric will be washed frequently, use a heavy backing. Backing will gradually become softer after many washes.

Backing is available in the colors black and white. White is the most common, and is used for most embroidery projects. Some embroiderers use black backing on darker garments, especially if there is any chance the backing might be seen or bleed through, such as on pique knit shirts.

Backing is available in large reels or pre-cut. Embroiderers opt for large reels when sewing large areas. Meanwhile, pre-cut backing is more convenient for smaller logos such as the typical left-chest logo.

Backing is available in different weights. The weight of the backing should correspond with the type of garment you are embroidering. Basically, the backing depends on how much you need to stabilize the fabric. The goal is to eliminate the stretch. The more the garment stretches, the heavier the backing needs to be. The general rule of thumb for selecting the corresponding backing: For lightweight garments, use heavier backing. For heavyweight garments, use lighter backing.

Below are the common weights for backing.

- a. Lightweight: 1 to 1.5 oz.
- b. Medium-weight: 2 to 2.75 oz.
- c. Heavyweight: 3 to 3.5 oz.

**TIP:** Embroidery is all about experimenting until you feel comfortable with your design. If necessary, you may use multiple pieces of backing or a combination of different-sized backing.



Figure 55

THERE ARE SEVERAL CATEGORIES OF BACKING USED IN EMBROIDERY. EACH HAS ITS OWN USE AND IS SUITABLE FOR DIFFERENT TYPES OF GARMENTS.

## Cut-away

Cut-away backing is used for permanent support, as it provides the most stability. It comes in light to heavy weights and is heat set fusible. It offers the sharpest embroidery on highly detailed designs, including small lettering.

Cut-away backing remains permanently affixed to the fabric, and the excess is cut away with scissors, which is how cut-away backing has earned its name. It is available in 1 oz. (light) to 3.75 oz. (heavy). Cut-away is best used on materials that stretch (such as knits) and fabrics that will be worn and washed frequently, as it prevents the design from stretching. It is also used on loosely woven and unstructured caps. Select a lightweight cut-away for designs with light stitch-density and a heavy weight cut-away for dense designs. If you're not sure if your fabric falls under the "stretchy" category, you can actually feel the fabric to verify. To do so, grab the material with both hands approximately 8 inches apart, and pull on the fabric. Make sure you are in the middle of the fabric, not near an elastic waistband or a zipper. If there is substantial stretching, you should use cut-away backing.

## Tear-away

Less stable than cut-away backing, tear-away backing is used for light support. It's available in light to heavy weight and also carries an adhesive version. Like cut-away, tear-away backing is true to its title. Embroiderers tear this backing away from the garment, hence the name. Tear-away backing is typically used on firmly woven, natural-fiber fabrics that don't stretch, such as terry cloth, robes, blankets, leather and more. In addition to being suitable for very strong and stable fabrics, tear-away is also used when you don't want the backing to show on the other side of the design, such as back of towels, caps and bags. When your fabric requires strong support, you may use several layers of lightweight to medium-weight tear-away. This method is easier because you'll remove one lighter sheet at the time, rather than struggling to remove a heavier tear-away.

## Specialty backings

Poly mesh or no show backing is a lightweight woven cut-away that is soft, thin and strong. It is designed to provide additional stability to knit shirts. This type of stabilizer does not show through light-colored garments, hence its name. It is used on polos and T-shirts that will carry designs with a low stitch count. For best results, we recommend combining a no-show backing with a tear-away backing. No-show backing may be removed with water or heat.

## Topping

Aqua-top topping is a water-soluble plastic film used on the top of an embroidery design to prevent stitches from sinking into textured fabrics. It is used for temporary support on delicate, mesh-like and difficult-to-mark fabrics like pique, fleece, terry cloth or corduroy. Topping is also highly recommended when embroidering towels, as it allows the stitches to stand out as much as possible. When using topping, it is still necessary to apply backing on the back of the fabric to stabilize the garment. Topping may be removed by tearing it away, spraying water on it, or a combination of both methods.

## Foam

Foam is used to add dimension to lettering or designs on caps for a 3D effect. It is available in a variety of colors in sheets up to 3 millimeters thick. The foam sheet is laid on top of the desired area and then stitched over with a column fill that uses short stitches to cut the foam. The excess foam will need to be pulled away. Some stray pieces of foam that remain can be removed by applying a hot hair dryer over the area.

## Poly mesh backing

While extremely thin, poly mesh backing is exceptionally strong because of the fibers it consists of. This backing is used for adding maximum stability if you don't want to handle the bulkiness of a heavyweight cut-away. Poly mesh is great for the newer tech garments, as they are very thin and

have a lot of fluidity to the fabric. Poly mesh will add support without compromising the stability of the garment. An instance where you may use this backing: when embroidering a stretchy tech golf shirt. In this case, you may layer two sheets of poly mesh.

## Fusible backing

Fusible backing is used on very stretchy materials. Once fused to the garment, the fabric and the backing become one stable material. It is also used to cover up a finished piece of embroidery, such as an infant's onesie, where the stitches and the backing would otherwise irritate the baby's skin.

# BACKING AND NEEDLE RECOMMENDATIONS

## Canvas

- Light to medium tear-away backing
- 75/11 sharp or normal round-point needle
- Sharp needles are better for longer runs

## Canton fleece

- Use light tear-away polyester backing to maintain color if a garment is subjected to extensive sunlight, chlorine, salt water or industrial laundering and bleaching.
- 75/11 light ballpoint needle

## Coated or waterproofed fabrics

- Use a light to heavy tear-away backing
- 75/11 or 80/12 sharp or light ballpoint needle

## Corduroy

- Use a medium topping and light to medium tear-away
- 75/11 light ballpoint needle

## Cotton sheeting

- Use a heavy cut-away or tear-away/ wash-away
- Cotton-on is great for children's clothing
- 75/11 light ballpoint needle

## Denim

- Use a heavy cut-away or tear-away/wash-away
- 75/11 light ballpoint needle

## Dress shirt (woven)

- Use a heavy cut-away or tear-away/wash-away
- 75/11 or 70/10 light ballpoint needle
- 80/12 needle for small details

## Golf shirt

- Use a light to heavy cut-away
- Heavy knits require a medium to heavy cut-away
- Medium knits require a light cut-away
- 75/11 light ball point needle

## Headwear

- Use a medium to heavy tear-away
- 75/11 or 80/12 sharp needle

## Leather and vinyl

- Use a light tear-away
- 75/11 or 80/12 light ballpoint on stiff or spongy leather (upholstery luggage)
- 70/10 or 80/12 sharp on soft, supple garment leathers

## Lingerie or silk

- Use a water-soluble tear-away backing
- 70/10 or 80/12 light ballpoint needle depending on thread

## Lycra or spandex

- Use a medium cut-away or water-soluble tear-away
- 70/10 medium ballpoint needle

## Nylon windbreaker

- Use a light to heavy cut-away
- 75/11 light ball point needle

## Satin jacket

- Use a light to heavy cut-away
- Cotton-on-cotton is a nice look
- 75/11 light ball point needle

## Sweater knit

- Use a medium to heavy cut-away
- 75/11 light ballpoint needle

## Sweatshirt

- Use a heavy tear-away or cut-away
- 75/11 light ballpoint needle

## T-Shirt

- Use a light, water-soluble tear-away or medium cut-away
- 75/11 light ballpoint needle

## Terry cloth

- Use a medium weight, water-soluble tear-away and topping
- 75/11 or 80/12 light ballpoint needles

## HOOPS AND BRACKETS

Your Ricoma MT Series embroidery machine includes a set of twelve (12) hoops per head. There are six different sizes ranging from A to F. Hoop A is the smallest hoop and hoop F is the largest hoop. You will receive two of each hoop. The size of the design and the placement of the design will help you determine which hoop to use. A general rule of thumb most embroiderers use: Always use the smallest hoop that your design will fit in without hitting the frame. When you upload your design, you will be able to use the preset hoop feature on the machine to make sure your design is within the frame.

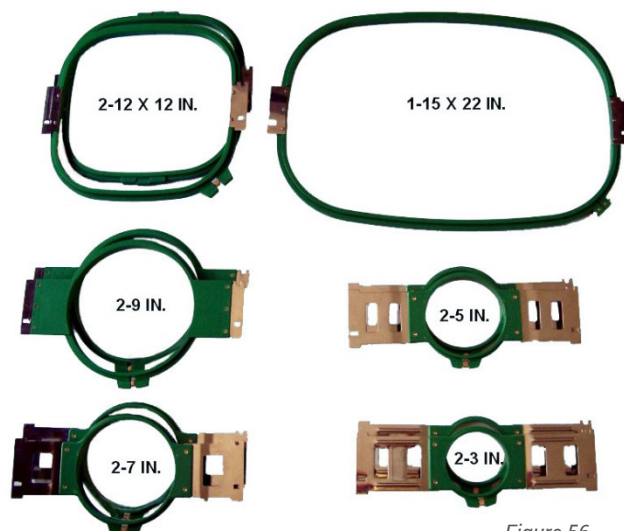

Figure 56

Using the smallest hoop your design will fit in will create the best hooping tension for your fabric. Whenever you are using a square or rectangular hoop, the only places you are really getting a grip on the fabric is in the corners. In contrast, round hoops have equal holding power all around the circle. Adjust the hoop tight enough to hold the weight of the garment, but not so tight that you strip the adjustment screw out of the hoop.

# HOW TO ATTACH THE FLAT FRAME BRACKETS

In order to attach the hoops to your machine, you will first need to connect the two metal hoop brackets onto the pantograph rail. These metal hoop brackets will support your hoops when embroidering on flats. You will need to attach the brackets to different slots on the pantograph rail depending on the size of the hoop you will be using. See Figure 57.

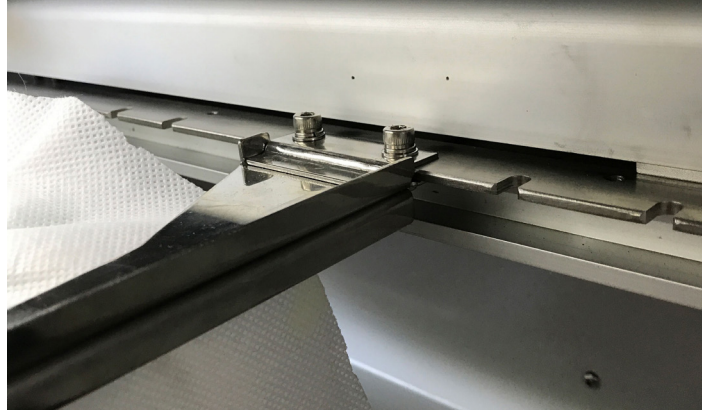

Figure 57

1. Locate the two hoop brackets that come with your machine. When attaching the brackets to the pantograph rail, make sure the brackets are facing each other, with the curved side facing the inside and the flat side facing the outside. See Figure 58.
2. Attach the brackets to the corresponding slots on the pantograph rail of the machine. Your regular hoops, hoops A-E, need to be attached to slots 5 and 6 of the pantograph rail. And your largest hoop, hoop F, needs to be attached to slots 1 and 2 of the pantograph rail. To locate the correct slot, count the slots on the pantograph rail from the outside to the inside with the first two slots being number 1 and 2. See Figure 59.
3. The brackets are composed of two metal plates with a slot in between them. When you attach the brackets to the machine, make sure the pantograph rail is positioned in between the two metal plates and the screws are lined up with the slots. See Figure 60.



Figure 59

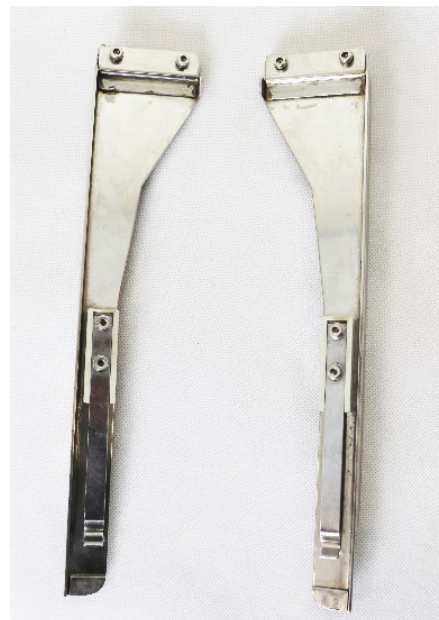

Figure 58

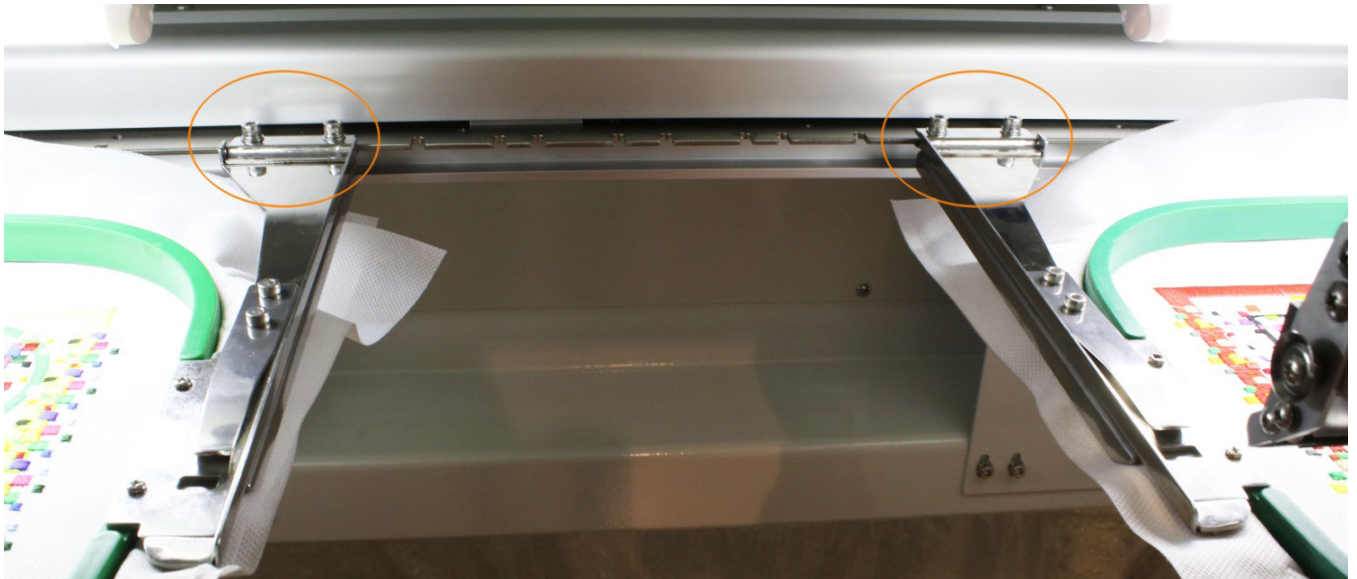

Figure 60



Figure 61

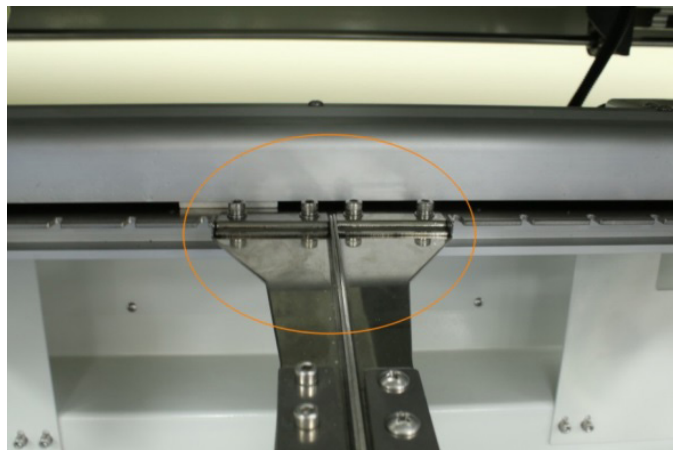

Figure 62

4. Attach the brackets using the provided bolts and the Allen wrench displayed in Figure 61.

**NOTE:** When using hoop “F” you will notice the two brackets in between the heads will be next to each other. See Figure 62.

## HOW TO REMOVE THE FLAT FRAME BRACKETS

You will need to remove the flat frame brackets when using the extended table or when embroidering on caps. To remove the flat brackets, loosen the arms by rotating the screws counterclockwise with the provided Allen wrench. Then pull the arms straight out toward the front of the machine. See Figure 63.



Figure 63

## HOW TO INSERT THE HOOP INTO THE MACHINE

The metal arms of the hoops are designed to slip under the clips on the hoop brackets. To correctly insert the hoop onto the brackets, make sure the open-ended slot (the U-shaped notch) is facing the machine. You should see the U shape on the top edge of the hoop, and it should always be on the right side. See Figure 64.

1. To insert the hoop into the machine, make sure the U-shaped notch is positioned correctly (facing the front right side of the machine). **NOTE:** When hooping, you must remember to orient the garment so that the leading edge of the hoop is the one with the U-shaped notch. See Figure 64.



Figure 64

2. When inserted correctly and completely, the edge of the hoop slips under the recessed notch at the end of the clip. The notches in the hoop will be held securely under the prongs near the end of the clips. See Figure 65.



Figure 65

**TIP:** Always do a sew-out on two pieces of backing or on a piece of the same material as the garment. This will help you see if the correct backing, topping and hooping methods have been applied. This will also help you verify if the tension of the thread and bobbin are correct.

### **NOTE:**

To insert the extra-large hoop, the brackets must be attached to the outermost slots (1 and 2) on each end of the pantograph rail. To correctly attach the extra-large hoop, recess the bottom hoop so that it clears bracket hardware. The wall of the extra-large hoop is taller to accommodate this.

## HOW TO REMOVE THE HOOP FROM THE MACHINE

To remove the hoop, lift the hoop arms to release the pressure on the notched areas. See Figure 66 and 67. The hoop brackets will hold the hoops very tightly at first, but it will gradually become easier to lift the hoop from the bracket as you pull the hoop out.



Figure 66



Figure 67

## HOW TO HOOP AND HOOPING RECOMMENDATIONS

Proper hooping is a fundamental step in the embroidery process. Your MT Series embroidery machine includes twelve (12) hoops per head. When determining which size hoop to use, make sure you select the smallest hoop that your design will fit in.

Backing stabilizes your fabric, adding rigidity and guarding against stretch. When hooping your fabric, you will need to select the proper backing that corresponds with your garment. Stabilizer should neither be too heavy nor too light. Please refer to the Backing section for more information on selecting the appropriate backing for the material you're using.

When your garment is hooped correctly, you should be able to run your fingers over the fabric without it moving or rippling. If your garment is too loose, remove the hoop and repeat the process. Never pull the fabric or tighten the hoop to even it out. Stretching the material while hooped will cause puckering, pinching and design position problems.

The market carries many tools that embroiderers use to simplify the hooping process. For example, embroiderers use temporary adhesive spray or adhesive backing for added stability on difficult-to-hoop items or highly stretchy materials.

### Magnetic hoops

Magnetic hoops are a great solution for hooping very thick material such as bags. These hoops provide much stronger support to your garment and ensure the fabric remains held securely within the hoop. Another solution for difficult-to-hoop items is the 8-in-1 device, which works for hard-to-embroider areas such as pockets, shirt sleeves and more.

# HoopMaster

Embroiderers use this hooping board to attain a uniform placement of the hoop and garment to maintain consistency when hooping multiple items. The board holds the outer ring of the hoop. Then, you would place the garment over the board and top it off with the outer hoop ring. The HoopMaster is known to be the easiest to use embroidery hooping aid on the market. Its many patented features make hooping simple, quick and more consistent. Plus, it's custom-made for your hoops, so there is no hardware to adjust.

## Finding the center of your design for a left-chest logo

Before hooping your garment, you must determine the proper placement of the design. To determine where to place the design, you must first find the center of the design. Keep in mind: The center will vary on the size of the garment you are embroidering and the size of the design you are stitching.

Design placement recommendations for a typical left-chest logo are as follows:

- **WOMEN'S:** Mark a point about 5 to 7 inches down from the area where the shoulder seam and the collar meet. Mark another point about 4 to 5 inches from the center of the shirt. Place the center of the design at the intersection of the points.
- **MEN'S:** Mark a point about 7 to 9 inches down from the area where the shoulder seam and the collar meet. Mark another point about 4 to 5 inches from the center of the shirt. Place the center of the design at the intersection of the points.

### TIPS TO KEEP IN MIND:

- The design should always be slightly closer to the center placket (front center) than to the armhole seam.
- If desired, mark the center with a water-soluble pen, a piece of masking tape or painters tape.
- Insert the bottom hoop ring either through the bottom of the shirt or through the opening in the neck area. Many embroiderers insert the hoop through the bottom of the shirt to avoid unbuttoning the collar. This also reduces the chance of soiling the collar area during embroidery.
- Regardless of whether you prefer to load the shirt through the neck opening or bottom opening, you must remember to orient the hoop so that the U-shaped notch is the leading edge of the hoop. When hooping the garment, make sure the hoop is facing in the same direction as it will enter the machine.



Figure 68

## HOOPING A POLO OR GOLF SHIRT

1. Place the bottom ring inside the shirt. Make sure the adjusting screw on the bottom ring is facing the bottom opening of the shirt. That way, you can quickly adjust the screw in the event that the hoop is either too tight or too loose.
2. Place the backing over the bottom ring, making sure all areas of the hoop are completely covered.
3. Place the top ring over the front of the garment, and align it with the bottom hoop. Push down on the hoop to insert the top ring into the bottom ring.
4. After inserting the top ring into the bottom ring, verify you've hooped the fabric correctly. Make sure the fabric is smooth and tight, but not stretched. Try to lift the fabric from the stabilizer. If it's difficult to lift, your fabric should be hooped correctly. See Figure 69.
5. Last, turn the garment over to confirm that the stabilizer covers all sides of the hoop. If it does not, re-hoop the garment.

Correct



Figure 69

Incorrect



Figure 70

## HOOPING A HOODIE OR JACKET

Like all other garments, hooping a hoodie or jacket requires finding the proper placement of the design. A good starting point is about 8 inches below the center shoulder seam. However, the placement of the design will vary based on the size of the design and the size of the garment.

1. Unzip the zipper and place the bottom ring inside the jacket as shown in Figure 71.
2. Position the stabilizer over the bottom ring, making sure it completely covers all sides of the hoop. See Figure 72.
3. Place the top ring over the front of the garment, and align it with the bottom hoop. Push down on the hoop to insert the top ring into the bottom ring.
4. After inserting the top ring into the bottom ring, verify you've hooped the fabric correctly. Make sure the fabric is smooth and tight, but not stretched. Try to lift the fabric from the stabilizer. If it's difficult to lift, your fabric should be hooped correctly.
5. Once hooped, the stabilizer should cover all areas of the hoop. If it does not, re-hoop the garment. See Figure 73.



Figure 71



Figure 72



Figure 73

# HOOPING PLACEMENT RECOMMENDATIONS

## Beach towels

- Designs should be centered 5 inches above the hem
- Monogram size should be 4 to 5 inches

## Bath towels

- Design should be 2 inches above the border or 4 inches above the hem
- Monogram size should be 3 to 4 inches

## Hand towels

- Design should be 1 to 1 ½ inches above the border or 2 inches above the hem
- Monogram size should be 2 ½ inches to 3 inches

## Fingertip towels

- Design should be centered 2 ½ inches from the hem
- Monogram size should be 2 ½ inches

## Wash cloths

- Design should be 2 inches above the hem or 1 ½ inches above the border
- Monogram size should be 1 to 2 inches

## Napkins

- Design should be centered in the corner of the napkin on opposite side of the label
- Monogram size should be 1 to 2 inches

## Pillowcases

- Design should be placed 3 inches above the hem
- Monogram size should be 1 ¼ to 2 ¼ inches

## Sheets

- Design should be centered 2 inches above the sewn band of the sheet, but sewn on the reverse side so it's visible when the sheet is folded over (many customers prefer full names – especially on children's sheets)
- Monogram size should be 3 inches on hem or 3 to 5 inches above the hem

## Robes – Men's

- Design should be 7 to 10 inches from the shoulder seam and 3 to 5 inches from the center

## Robes – Women's

- Design should be 4 to 6 inches from the shoulder seam and 3 to 5 inches from the center

# HOOPING CAPS

When sewing caps, you will need to use the following materials: the cap driver, the cap station, a cap ring, a blank cap and backing (usually tear-away).

The cap driver is the accessory that is mounted on the machine. See Figure 75. This tool holds the cap and cap ring during the sewing process.

The cap station is the tool that holds the cap ring (the cap hoop) while hooping. The cap station should be mounted on your machine stand or on a sturdy table. See Figure 76.

Once you have mounted the cap station, you can attach the cap ring to the cap station to begin hooping.

The cap ring is the hoop for your caps. This ring can be adjusted depending on the thickness of the cap's fabric. To do so, loosen the three screws using pliers. Tighten the screws once you have reached the desired position for the band. **NOTE:** The remodeled cap rings come with an adjustable band.



Figure 75



Figure 76



Figure 77

## Hooping the front or sides of a cap

1. First, make sure the cap ring is connected to the cap station. To do so, connect the open metal notch on the cap ring to the center tab on the cap station. Grab the cap ring from the back, and push it forward. Make sure the cap ring snaps into all three of the spring locks on the cap station.
2. Once the cap ring is connected to the cap station, unfasten the metal band and let it rest to the left side of the cap ring.
3. To prepare the cap for embroidery, make sure the bill of the cap is as flat as possible. Unfasten the straps on the back of the hat if any.
4. Pull back the sweatband located below the bill of the cap. Make sure the entire sweatband is pulled back from seam to seam. See Figure 78.

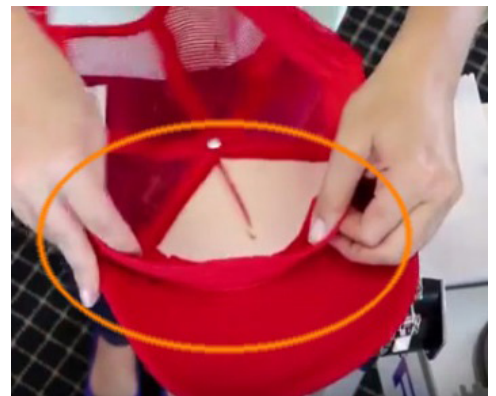

Figure 78

5. Place the backing under the bill stop (the metal tab on the top of the ring). See Figure 79.
6. Slide the hat onto the cap frame, keeping the sweatband under the bill stop. Make sure the cap is pushed up tightly against the bill stop, not on top of it.
7. Position the flexible metal strap over the cap's bill, keeping the serrated edge of the band as close to the bill as possible. See Figure 80.

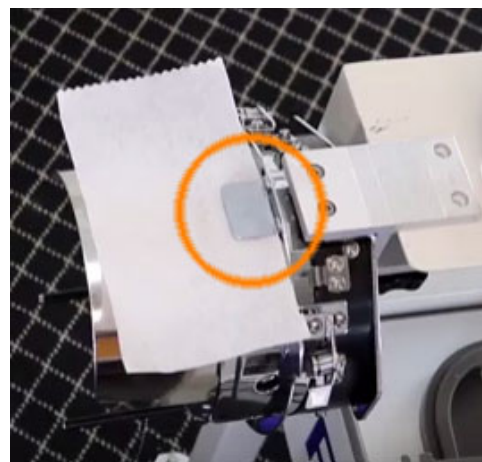

Figure 79

**NOTE:** The older models carry a metal strap with two bands, rather than one. One band has a serrated edge, and the other band has a smooth edge. If that is the case, make sure the bill is positioned in between the two metal bands. The band with the serrated edge should be placed on top of the bill, and the band with the smooth edge should be placed underneath the bill.



Figure 80

8. Connect the clasp to the cap ring latch and snap it into place. See Figure 81. Pull the sides of the hat to make sure it is tight and not wrinkled.
9. Pick up the excess fabric on the back of the hat, and secure it using the provided metal clips. Clip the fabric to the metal bars inside the cap ring to keep the cap tight. Make sure the handle of the clips face the center of the cap and toward each other. See Figure 82.



Figure 81

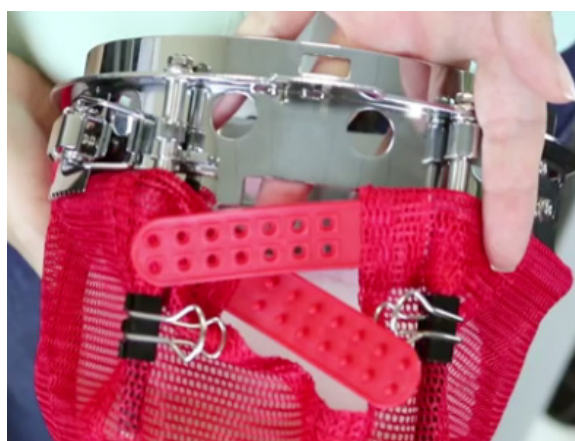

Figure 82

## Hooping the back of the cap using a round hoop

1. Take your 12 cm or 15 cm hoop.
2. Find a surface that is the width of the bottom ring of the hoop you have chosen. The corner of a table would work.
3. Place the bottom ring on that surface.
4. Place your backing on top of the bottom ring. It would be helpful to use adhesive spray on the backing or adhesive backing.
5. Place the cap on top of the bottom ring and backing.
6. Smooth out the material, eliminating any wrinkles.
7. Place the top ring over the fabric, and align it with the bottom ring.
8. Join the top and bottom ring, as you would with flats.

## HOW TO INSTALL THE CAP DRIVER

1. First, select the cap hoop on your control panel. You will find the preset hoop function under the Design Set Parameters menu. Press the Design Set key to access this function. Once you have selected the preset cap hoop, the pantograph will move forward.
2. If you haven't done so already, make sure the flat support brackets are removed. To remove the brackets, loosen the Allen screws that attach the brackets to the pantograph rail. Use the provided Allen wrench to loosen the screws just enough to be able to slide the brackets off. **NOTE:** It's not necessary to completely remove the screws. This will make it faster to reattach the brackets when you switch to flats.
3. Insert the cap driver on the machine, making sure the sewing arm goes through the opening in the back of the cap driver. Each cap driver and cap ring is numbered. Use the cap driver labeled "1" for head 1. Use the cap driver labeled "2" for head 2.
4. The cap driver is equipped with four small wheels that slide onto the rail underneath the sewing arm of the machine. Position the cap driver in line with the railing, making sure all the wheels are aligned. See Figure 83.
5. Push the cap driver toward the machine until it reaches the pantograph. You will attach the cap driver to slot 6 on each end of the pantograph. The right screw should be placed on the 6th opening from the right end of the pantograph. The left screw should be placed on the 6th opening from the left end of the pantograph.

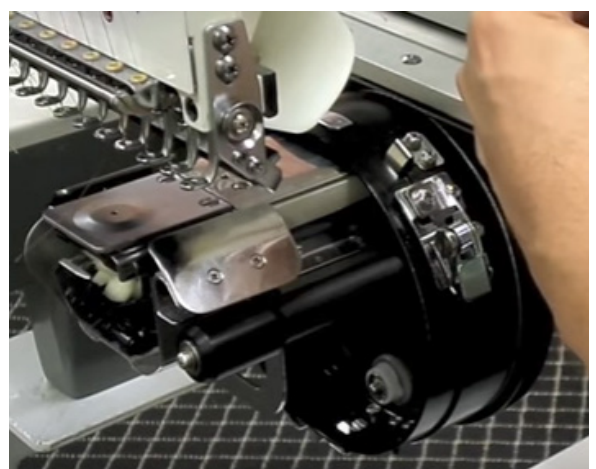

Figure 83

6. Tighten the Phillip screws using the provided Phillip screwdriver to secure the cap driver to the pantograph.
7. If using both heads, repeat this process on the remaining machine head.
8. Last, verify the cap drivers have been installed correctly by testing how it moves along the pantograph rail. Using the directional arrows on your panel, make sure both cap drivers are moving freely from front to back and side to side.

## HOW TO REMOVE THE CAP DRIVER

1. Using the Phillip screwdriver included in your toolkit, loosen the Phillip screws that connect the cap driver to the pantograph. You should find the screws on slot 6 of each side of the pantograph rail.
2. To remove the cap driver, carefully pull the cap driver toward you using both hands. Keep in mind: It's not necessary to completely remove the screws. It should be able to slide off easily if you have loosened both Phillip screws.
3. Repeat this process with the remaining head.

## HOW TO INSTALL THE EXTENDED TABLE

Your embroidery machine includes an extended table designed to embroider larger areas and heavier garments. Before installing the extended table, make sure your table support brackets are secured into place. Your machine contains brackets on each side of the machine, and another set of brackets underneath the sewing arm. See Figure 84 and 85.

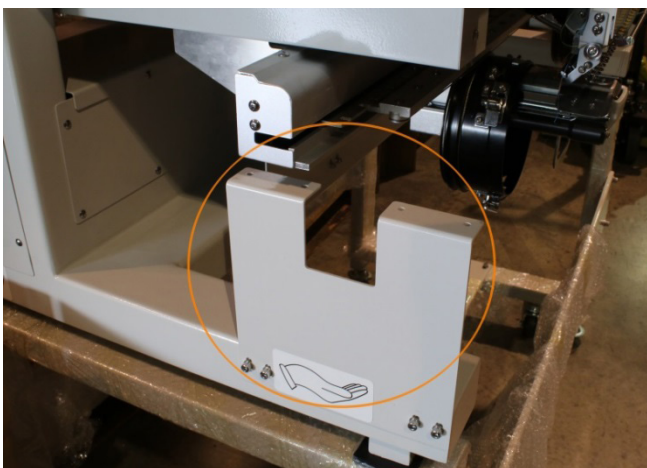

Figure 84

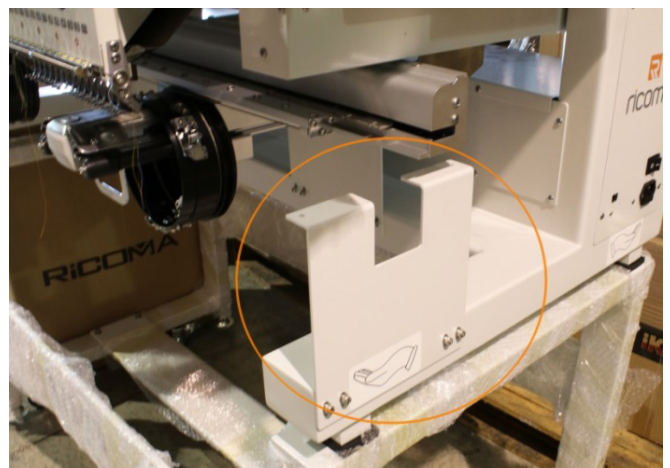

Figure 85

1. Slide the table on until it reaches the machine body and rests comfortably on the table support brackets. See Figure 86. Use the openings as a guide to help you see where to position the table. The sewing arms should rest in between the table openings. See Figure 86.
2. After you've made sure your table is in place, take the two magnetic table support legs, and place them in their corresponding slots underneath the table. See Figure 87.

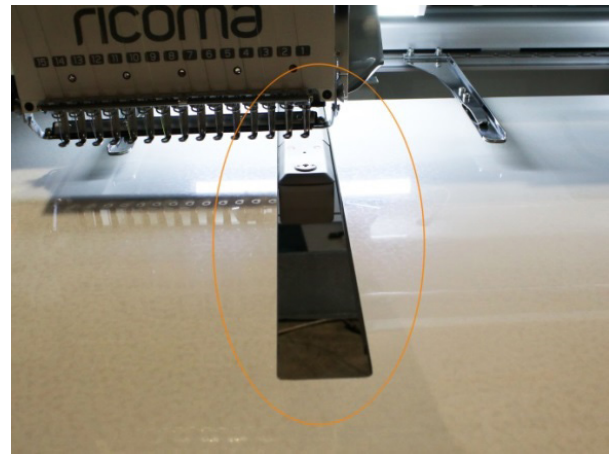

Figure 86



Figure 87



Figure 88

3. Level the table support legs by rotating each peg counterclockwise until they reach the floor. Then, tighten each nut. See Figure 88.
4. Locate the security latches underneath the table. Tighten each latch until the rubber stop meets the bottom of the table. You should hear it click into place. See Figure 89 and 90.



Figure 89



Figure 90

# ATTACHING THE SASH FRAME



Figure 91

The sash frame is the largest frame (hoop) included with your machine. It will be used along with the extended table. See Figure 91.

Before attaching the sash frame to the pantograph, make sure the extended table has already been installed. For instructions on attaching the extended table, please refer to the “How to Install the Extended Table” section. Once the table is attached, place the sash frame on top.



Figure 92 & 93

1. Loosen the two Phillip screws located on the outer edge of each end of the sash frame. See Figure 92.
2. Locate the washers that correspond with each of the Phillips screws. Pull the washers up in order to place the sash frame inside the pantograph rail. When inserting the sash frame into the pantograph, make sure the two washers end up on top of the pantograph rail. See Figure 93.

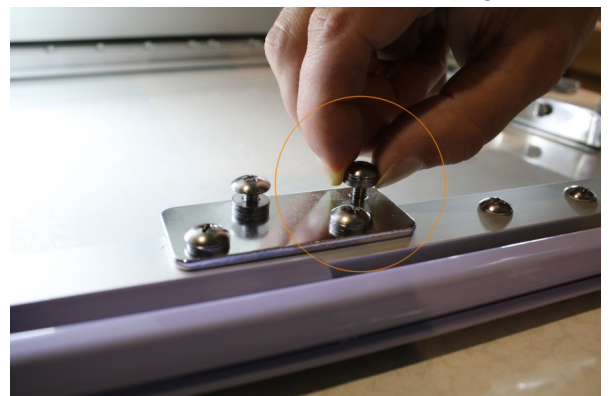

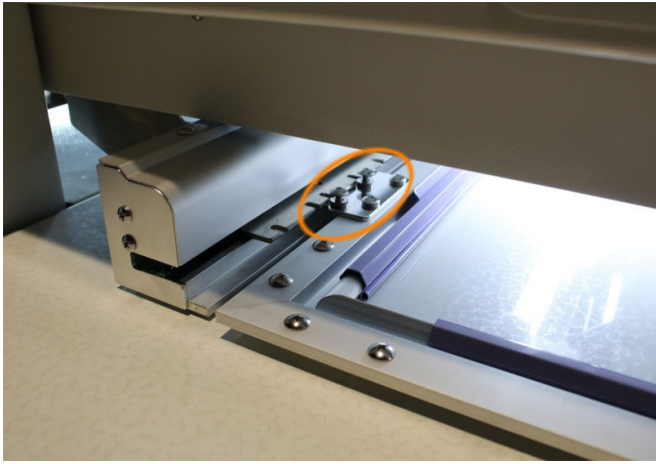

Figure 94

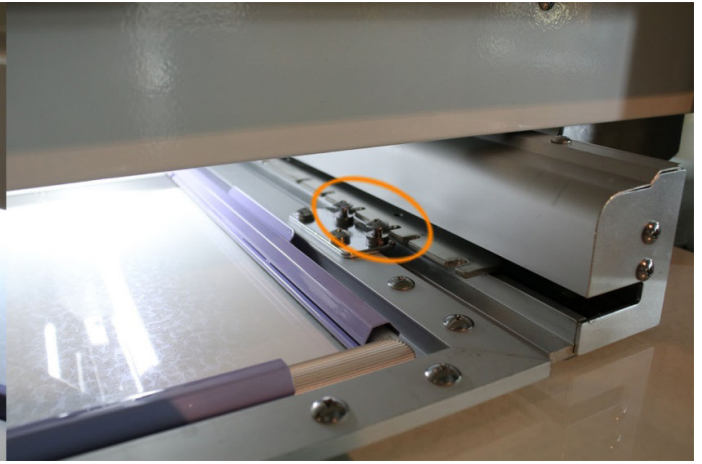

Figure 95

3. Make sure to attach the sash frame to slots 3 and 4 on each end of the pantograph rail. See Figure 94 and 95.
4. Last, tighten all four (4) Phillip screws.

## OPERATING SPEEDS FOR FLATS AND CAPS

Operating speed is determined by the quality of the design and the type of material you are sewing on. To ensure the quality of the product, you need to run your machine at certain speeds when embroidering different types of material.

**TIP:** While sewing, inspect your stitches. Make sure your design is coming out clean and tight without any loose or looping stitches. If stitches seem to be loose or poor quality, lower the speed of the machine until you have nice, clean stitches.

If you are experiencing an excessive amount of thread breaks, try reducing the speed of the machine if you've already ensured the following:

- Your design has been digitized correctly and contains the proper stitch count for its size
- You have hooped the garment correctly
- You have proper thread tension
- Your machine is threaded correctly

To adjust the speed of your machine, use the plus (+) and minus (-) buttons on your control panel's main menu.

**NOTE:** You may increase the machine's speed in increments of 10 or 50 using the frame shift direction key, located in the center of the four directional arrows on your control panel.

## Speed recommendations

- When embroidering caps, we recommend running the machine between 450 to 550 stitches per minute.
- When embroidering flats, we recommend running the machine between 650 to 850 stitches per minute.

## OPERATION PANEL AND KEY FUNCTION INTRODUCTION



### MANUAL TRIMMING KEY:

Used to perform trimming during operation status and preparation status.



### 100 DEGREE KEY:

Automates the process of aligning the machine to 100 degrees.



### FRAME SHIFT DIRECTION AND FRAME SHIFT SPEED KEY:

Used to adjust the movement of the frame along the pantograph rail and the increments in speed.



### DIRECTIONAL ARROWS:

Used to move the design up, down, left or right along the frame.



### SPEED ADJUSTMENT KEYS:

Used to increase or decrease the speed of the machine.



### TRACE DESIGN KEY:

Used to trace the design's start and end point.



### RETURN TO ORIGIN KEY:

Used to return to the beginning of the design.



### FRAME OUT KEY:

Used to offset the frame when creating appliqué.

**WORKING MODE/COLOR CHANGE MODE KEY:**

Used for setting color change mode from automatic to manual.

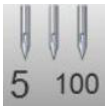
**NEEDLE SWITCH DISPLAY/WORKING NEEDLE/SHAFT NEEDLE KEY:**

Used to determine needle position and degree settings on the machine. The left side displays the current needle position and the right side displays the degree the machine is aligned to.

**COLOR SEQUENCE SETTING DISPLAY:**

Used to select color sequence settings. The left side displays the current working needle and any additional settings, and right side displays the upcoming working needle and its additional settings.

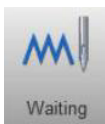
**MESSAGE KEY/FLOATING MODE KEY:**

Used to determine which status the machine is on, whether it's preparing, working or waiting. Also displays when an error occurs, such as thread breaks. Also used when fast-forwarding a design (floating).

**EMBROIDERY STATUS KEY:**

Used to set the machine in and out of embroidery mode. When the lock appears locked, the machine is in embroidery status. When the lock appears unlocked, the machine is in set-up mode.

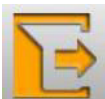
**GO TO ENDPOINT KEY:****BACK KEY:**

Used to escape from a menu.

**DESIGN SELECTION/FILE KEY:**

Used to import and export an embroidery design and to delete designs from the machine's memory.

**DESIGN SET PARAMETERS KEY:**

Used to select the preset hoops on the machine. Also used to increase and decrease the size of your design, rotate designs and create repetition.

**EMBROIDERY PARAMETERS KEY:**

Used to adjust the machine parameters. We do not recommend changing any settings without the help of a certified Ricoma technician.

**COMPREHENSIVE MENU SETTINGS:**

This key hosts the on-board lettering function and the IP settings on the machine to enable network connectivity.

# NETWORK CONNECTION

Your machine can be connected to your computer via the internet in order to embroider straight from the computer's memory without having to import any designs into the machine's memory. You will find a how-to video link below as well as a download link for the software needed to connect the machine to the computer.

HOW-TO-VIDEO: <https://www.youtube.com/watch?v=YITWq5YdUVs>

FILE DOWNLOAD: <https://drive.google.com/file/d/0B0mi2DtPyzllcEo0eml0WThLWWc/view?usp=sharing>

**If the settings in the video don't work, please try the following:**

1. Change PC IP to 192.168.0.50 and Machine IP to 192.168.0.51.
2. If you need to connect through a router, please set router IP 192.168.0.1.



Connected network

AX/AY: Display relative origin coordinates of embroidery card.



Disconnected network

PX/PY: Display absolute origin coordinates of embroidery card.

# HOW TO UPLOAD A DESIGN

Your Ricoma embroidery machine reads DST files, the most common of all embroidery file types. If your embroidery file is in another file type, you will need to change the file type by using the Wilcom software that comes with your machine. In order to run an embroidery job, you must first import a DST file into the machine using a USB. Keep in mind: You can't embroider straight from the USB, so follow these steps to upload the design directly to the machine's memory.

1. Once you have your DST file saved onto your USB, insert the USB drive into the USB port on the right side of the panel.
2. After inserting the USB, make sure the embroidery status is unlocked. You can do so by selecting the Embroidery Status key (lock icon) located on the top right corner on your control panel's main menu. If the Embroidery Status icon appears to be locked, the machine is on "embroidery mode." If the icon appears unlocked, the machine is on "setup mode." Ensure that your machine is on setup mode before moving on.

3. Press the Design selection/File key  to enter the embroidery card management interface.

4. If the USB was inserted correctly, your machine will automatically select the USB memory icon. 

This will display a list of available files on the memory stick. See Figure 96.

5. Select the file you wish to input. The design will now preview on the right side of the panel in the small screen. The stitch count, color, size, and other related information will also appear on the right side of the screen.

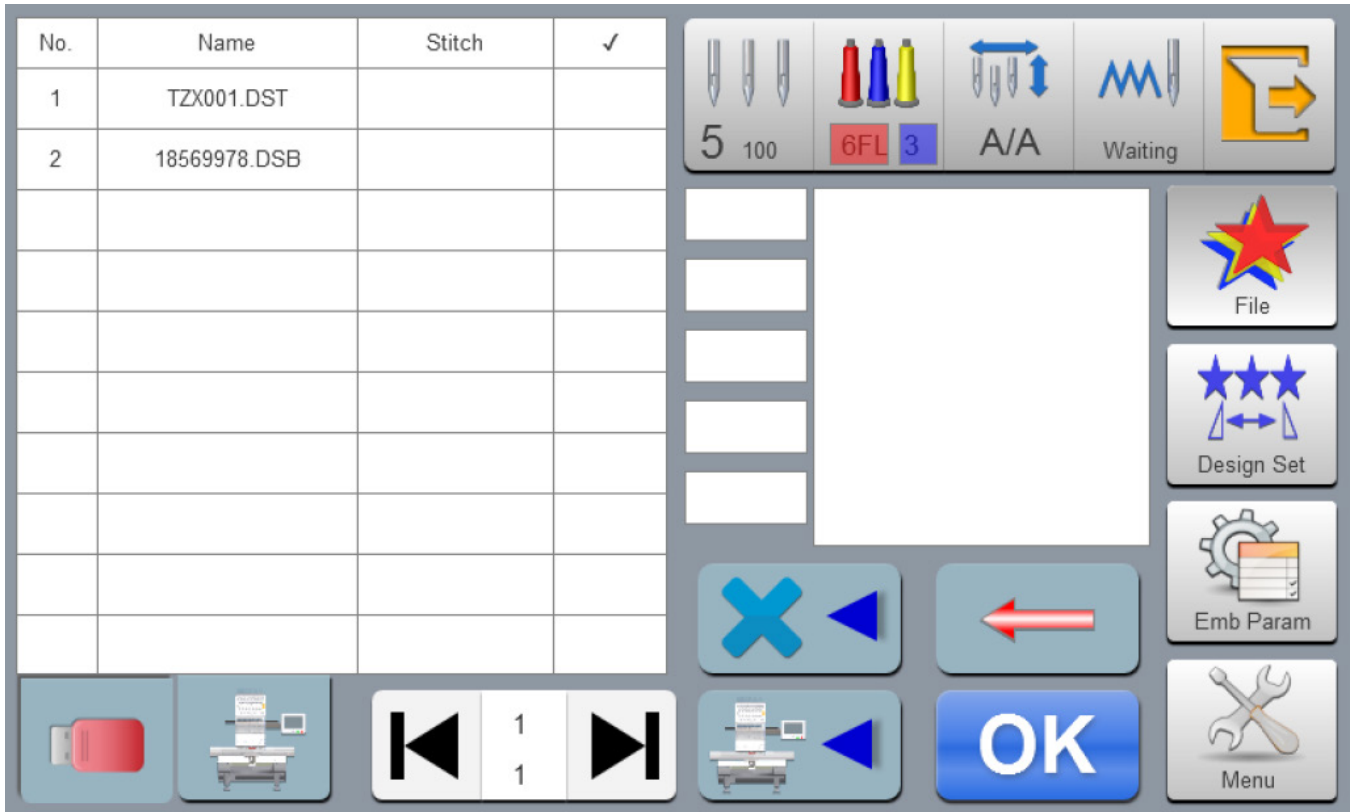





Figure 96

6. Press the "Import to machine" icon  to import the design into the machine's memory. A message reading "Loading" will appear on the screen. Your design is now saved onto your embroidery machine's memory.

## DELETING A DESIGN FROM THE MACHINE'S MEMORY

The machine's memory holds 200 designs or 2 million stitches. To clear space, delete the designs you'll no longer need. Follow these quick steps to delete a design from your machine's memory.

1. Press the Design selection/File key  to enter the embroidery card management interface.

- Now, select the machine's memory icon represented by an embroidery machine. This icon appears to the right of the USB memory icon. Selecting this icon will display a list of files in the machine's memory.
- Choose the design you wish to delete. Press the "Delete" icon  to delete the design. A message confirming your selection will display. Press OK to continue.

## EXPORTING A DESIGN FROM THE MACHINE'S MEMORY

- To export a design from the machine's memory to your USB, select the Design selection/ File key.  Once selected, the embroidery card management interface will display.
- Select the machine's memory key represented by the embroidery machine icon. A list will display.
- Tap the design you wish to export. If you have many designs saved on your machine's memory, navigate through the pages by selecting the black arrows until you find the correct file.



The top value represents the page you are currently on, and the bottom value represents the maximum number of pages.

- Once you select your design, an image of the design will display on the screen next to the file you've selected.
- Last, choose the Export to USB icon.  A message reading "Loading" will appear on the screen. The design has now been exported.

## EMBROIDERY STATUS SWITCHING

The embroidery machine has three embroidery statuses: preparation status, working status and running status.

To switch from preparation status (setup mode) to working status (embroidery mode), select the "Embroidery Status" key.

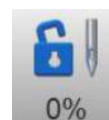

A message displaying "Enter Embroidery Status" will appear. Press OK to enter working status.



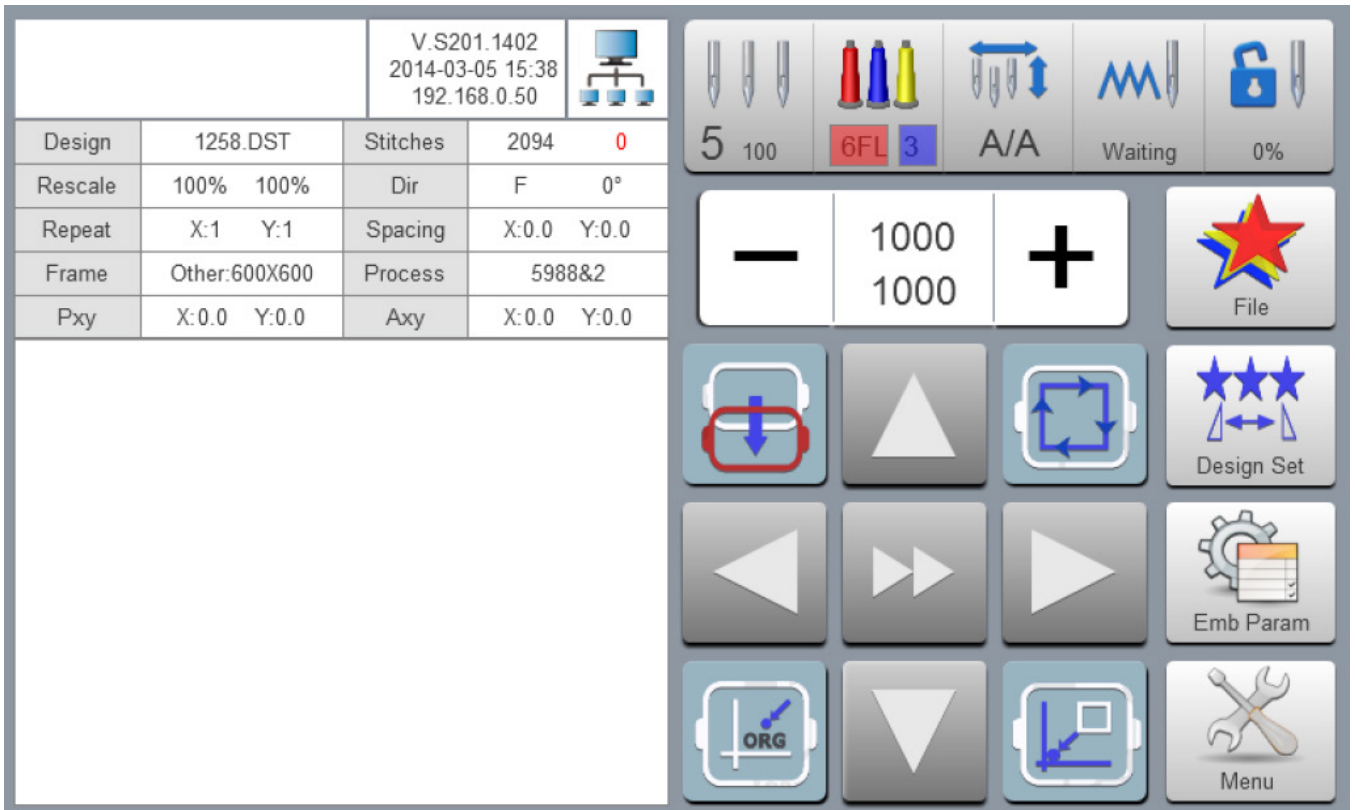

Figure 97

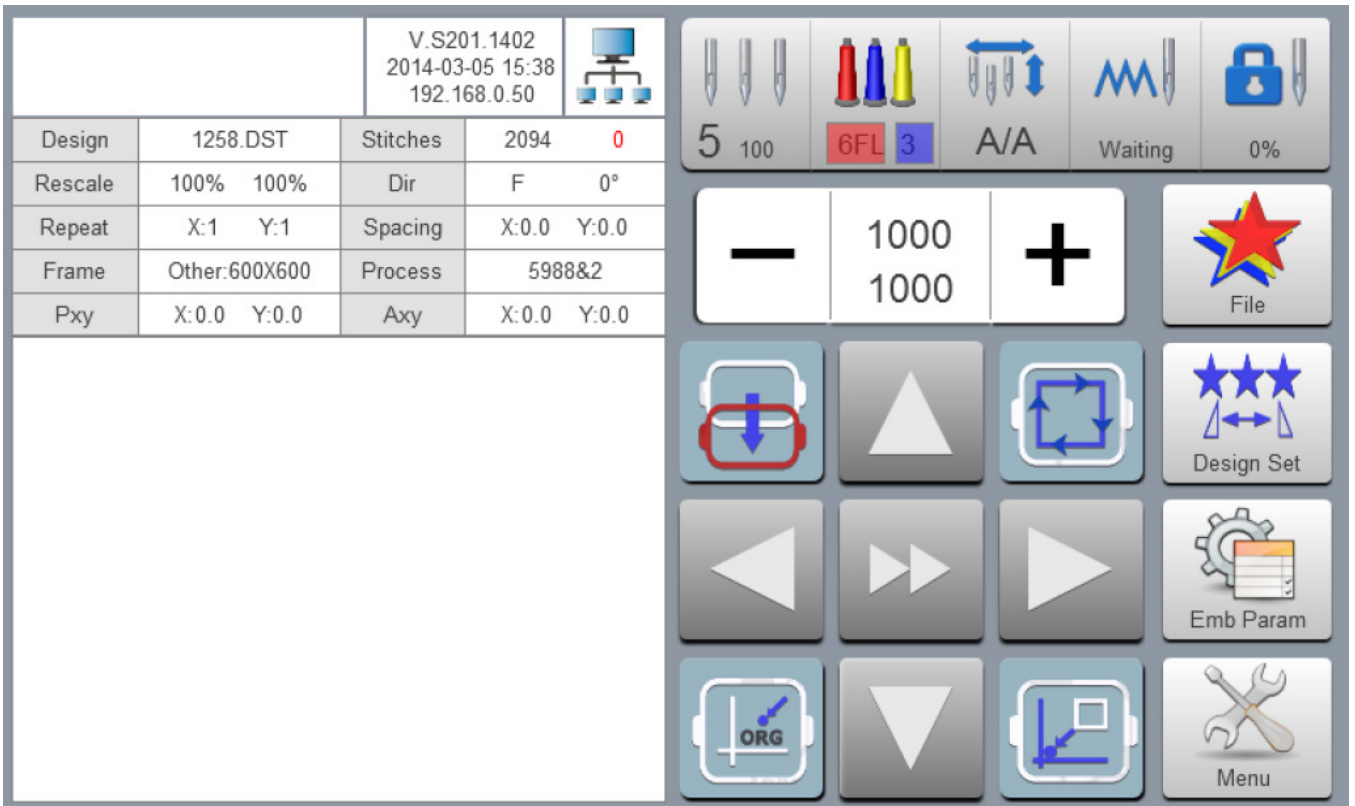

Figure 98

# DESIGN SET PARAMETERS

During preparation status, you may select the Design set parameters key to access the design set parameter settings menu. Under this menu, you will be able to command the machine to perform the following functions:

- Select the preset hoops on your machine
- Increase and decrease the size of your design
- Rotate your design
- Select a customized angle for your design
- Repeat a design
- Adjust the density of your design

See Figure 99.

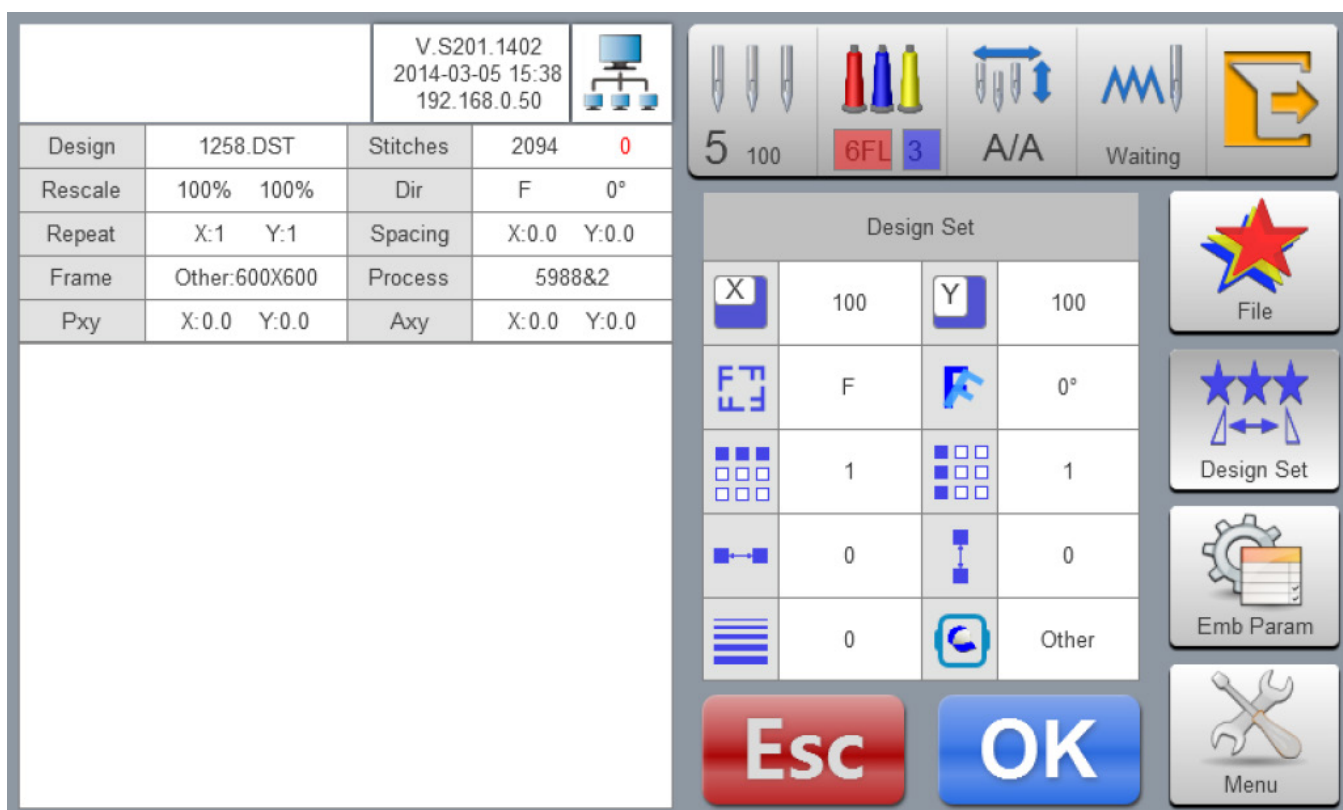

Figure 99

# PARAMETER RANGES AND FUNCTIONS

The design set parameters menu has a number of options that allow users to edit and customize the design before embroidering. See Figure 99.

## Rotate designs

The rotate designs function allows the user to rotate the design in eight different directions.

- 0°
- 90°
- 180°
- 270°
- 0° (mirror)
- 90° (mirror)
- 180° (mirror)
- 270° (mirror)

To do so, select the rotate designs key represented by the F icon on your design set parameters menu. When you select this key, a variety of options will appear. Select the desired position and press OK. The design will then appear on the screen with the changes you've made.

## Rotation angle

After you've rotated your design to a desired setting, you may also customize the rotation angle anywhere from 0 to 89°.

To do so, select the icon with one 'F' and one slanted 'F' to add a specific angle to your design. Once you select this option, a numbered keypad will appear. Select the desired degrees in which you would like to position your design, and press "ENTER." Now, press "OK." The logo on your screen should now appear in the customized angle you selected.

## Increasing and decreasing the size of your design

The X & Y axes are represented by the number 100. This means, the logo will be embroidered at 100 percent. You can increase or decrease the logo size by changing the X & Y measurements. These measurements can range from 50 percent to 200 percent.

To do so, first click on the "X" icon and press clear before inputting any value.

Next, input the desired value. Next, press the enter key represented by the green arrow.

Last, repeat these steps with the Y axis.

Keep in mind, if you change the measurements of either axis, you will need to change the measurements of the opposite axis by the same amount to avoid distorting the logo.

Last, press OK to save the changes.

**TIP:** When making these changes, keep in mind the machine will not increase or decrease the number of stitches on your design. A big difference in the percentage (%) may distort the embroidery. We recommend adjusting this setting to no more than 115% and no less than 85%.

## Repeating a design

Your machine is capable of repeating the same design in one job. Embroiderers use this method to save time when running projects such as multiple patches. To do so, you will need to use the largest hoop possible, and repeat the logo as many times as it fits in your hoop area.

To begin the process, you will have to choose whether you want to repeat your designs vertically or horizontally. To stitch the design horizontally, you will use the third and fourth icon on the first column of your design set menu. See Figure 99.

First, input the number of logos you plan on repeating by selecting the third icon in either the first or second column.

Before inputting a value, press clear. Then, input the number of logos you would like to repeat. Now, press "Enter." You may repeat up to 99 designs.

## Selecting the space between repeated designs

If repeating a design, you will need to select the space in between each of the designs by choosing the fourth icon on either the first or second column depending on whether you are repeating the design horizontally or vertically.

Next, input the amount of space you wish to place between your designs. These values will be represented in millimeters ("mm"). Once you've input the measurement, press "Enter," and then "OK."

Your repeated designs will now appear on the screen. Keep in mind that if the hoops are too small for all the designs, the hoop outline will appear in red. If this is the case, please change the hoop selection on your panel. The hoop you're using on the machine should be the same size selected on your panel.

**Note:** This system uses millimeters. Each unit represents 0.1 mm. Therefore, it will input 1000 when inputting 100 mm. The values that can be input range from 0 to 999.99 mm.

## Adjusting the density of the design

On the bottom left corner, you will find the density selection, which allows you to increase or decrease the density of your design.

If you would like to increase the density, tap the area where the number appears and input the desired density values. Density values range from 1 to 3, with 1 being the thinnest and 3 the thickest. In this case, were adjusting the density to 1 to increase the density of the design. After inputting the value, press "Enter," and then "OK."

If you would like to decrease the density, select the density key once again. Once selected, input your value. Then, click on the "+/-" icon to convert to a negative value. Last, select "Enter" followed by "OK."

**Note:** This selection will increase the density of the entire logo.

# SELECTING THE PRESET HOOPS ON YOUR MACHINE

Before embroidering, it is important to first select the preset hoop on your control panel to match the hoop you're embroidering with. To do so, follow these simple steps.

1. You will select the preset hoop that corresponds with the hoop you're using under the design set parameter settings. This setting is represented by an image of a cap inside a frame 
2. A list of all the pre-set hoops on your machine will now display. Your preset hoops are labeled A-G. Hoop "G" on your machine is the hoop for the sash frame. The cap option will be used for cap embroidery, and "Other" will be to be used for hoops that are not pre-set on your machine, such as the 8-in-1 hoop, or any other specialty hoop size. See Figure 100.
3. Select the hoop you will be using. Your machine will now position itself to match the preset hoop you've selected. **Note:** If a hoop is not selected, the system will continue to use the previously selected hoop.

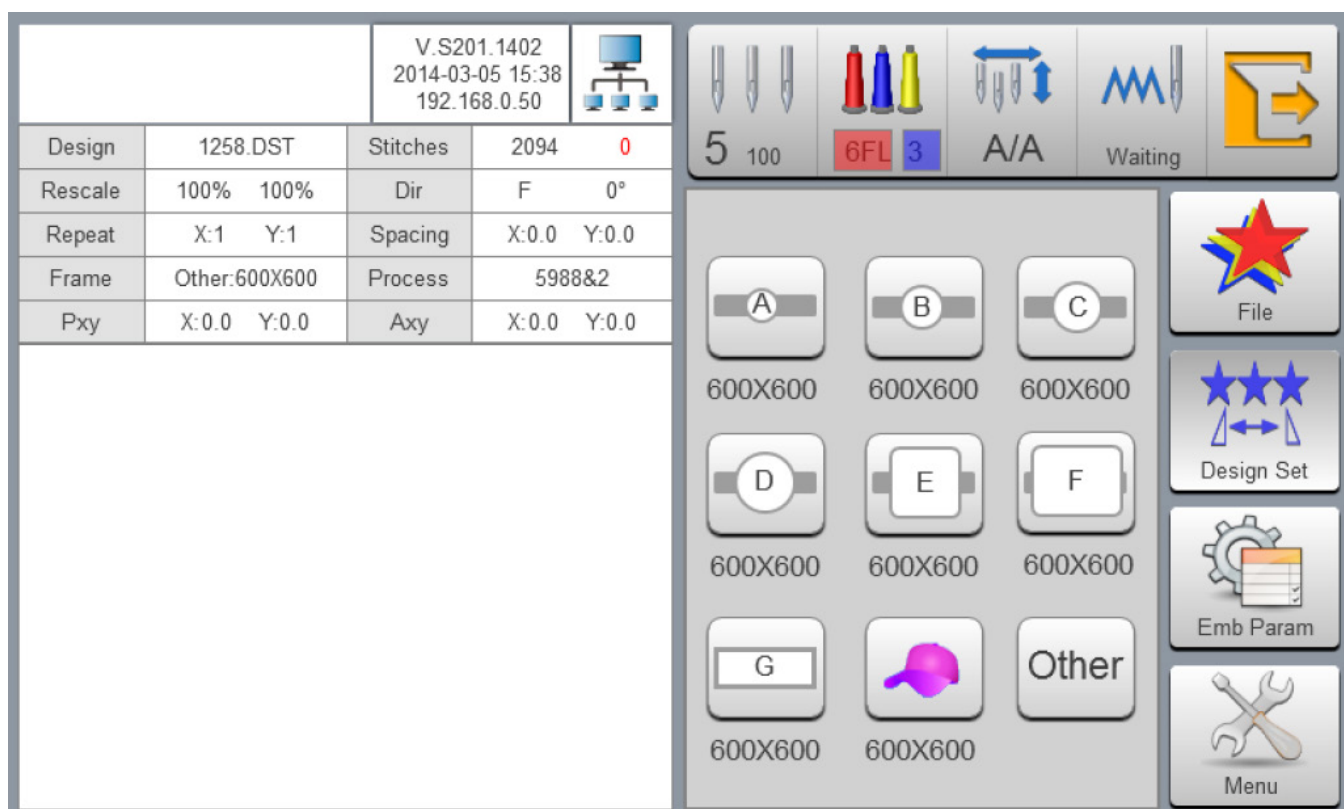



Figure 100

## TRACING THE EMBROIDERY AREA

Before running a design, it is a good idea to trace your design. This step will ensure the needle will not interfere with the hoop during embroidery. Follow these simple steps to perform a pre-sew design trace.

1. Select the tracing key located on the main menu. 
2. A message displaying “Enter embroidery status?” will appear. Press OK.
3. The machine will then move to needle one to begin tracing the design. Keep an eye on needle one to make sure the design is within the hoop boundaries.
4. Once the machine completes the outline, you have the option to do a contoured tracing of your design. You may do this only after completing the first trace.

## CONTOURED TRACING

Once the machine has completed its first tracing, the contoured tracing option will appear. The contoured tracing option is more detailed. It will trace around the exact outline of the design, rather than just the general area of the design. The key is represented by an icon of a stitched heart within a frame.

1. Select the contoured tracing key. The machine will now perform a contoured trace in slow motion.



## EMBROIDERY PARAMETERS

To access the embroidery parameters menu, select the Embroidery parameters key  on the main menu. In this menu, you will find all the embroidery settings for your machine. We do not recommend changing these settings without the help of a certified Ricoma technician.

## COMPREHENSIVE MENU SETTINGS

To access the comprehensive menu settings, select the comprehensive menu settings key  on the bottom right-hand corner of your control panel's main menu. Under this menu, you will find the following main functions:

- The “Factory settings and tests” option
- The different language selections available
- The IP address for networking your machine with your computer
- And the “on-board lettering” option

## RETURN TO ORIGIN (STARTING POINT)



The return to origin key will be used during the embroidery process. In the embroidery process, it is required returning to the origin to re-start the embroidering, it can take the operation.

Press  key. A message staying “Terminate embroidering and return to the origin?” will display.

Press the  key and the hoop is moved to the embroidery card origin and stop.

## FRAME OFF-SET HOOP OPERATION

In the embroidering process, if is required returning to the offset point, it can take the operation.

Press  key once and the hoop is moved to the offset point and stop. Press the  key gain, the hoop is moved to stop point and stop so it can continue embroidering.

## GO TO ENDPOINT

In the embroidering process, after hoop is moved manually, when it is required returning to the stop position of embroidery machine, it can take the operation.

Press  key to take operation of returning to the stop point. After the key is pressed, it is moved to the manual frameshift position automatically and stopped.

## NEEDLE SWITCH DISPLAY/ WORKING NEEDLE

The “needle switch display/working needle”  icon is located on the top left corner of the main menu.

This icon displays two important features on your machine. The large number on the left side represents the working needle, and the number on right side displays the degree the machine is aligned to.

In order to operate, the machine must have a needle selected and be aligned to 100 degrees. Therefore, make sure the number on the right side appears as 100, and that the number on the left matches the number of the needle you have selected.

To change the needle position, select this icon. Now, the needles labeled 1-15 will appear on your screen. Next, choose which needle you want the machine to use.

Now your machine head will align with the selected needle. Last, press  button to return to the main menu.

## SET COLOR SEQUENCE

Color sequence setting includes color changing sequences setting and needle bar replacement.

In working interface main menu, press the color sequence selection  key to enter into color changing interface. It defaults to enter into color changing sequences operation. See Figure 101.





Figure 101

## SET COLOR CHANGING SEQUENCES

In color changing sequences setting interface, press number key to enter into color changing sequences setting. Change color 1-200 times from the 1st page (the system supports max 200 times of color changing sequences). When the interface is opened, the cursor is started from the last value position with needle bar automatically. Press the number key and input corresponding needle bar number of current color changing sequence. The cursor is moved to next color changing sequences automatically.



In the setting process, if current needle bar number has error, click the selected number to reset the value. If there is no color changing sequence setting selected, it will use the current needle bar to embroider. If color changing times are not set as the max color changing number of current embroidery card, it will use the current set color changing number to take cycle orders.



Upper value in  1  means current page, and lower value means max pages of current embroidery card number. Left and right keys can take page turning. However, max page turning value cannot be larger than max pages of current embroidery card.

## APPLIQUE OFFSET, LOW SPEED EMBROIDERING AND NEEDLE BAR REPLACEMENT

If a certain color changing sequence that the cursor is located requires offset out of hoop (appliqué) at the end of the selected embroidery color stop sequence, press  key. An “F” is displayed behind current needle bar number. (See Figure 86 First Color stop sequence).





To remove the offset out of hoop setting, press  once again.

If a certain color changing sequence requires deceleration for embroidery at the end of embroidery (slowed speed is set at “low embroidering speed” in “speed parameters” of embroidery parameters, press  key. An “L” is displayed behind current needle bar number. To cancel low embroidering speed setting, press  once again.

If all color changing sequences of a certain set needle bar shall be replaced by another needle bar for embroidering, after pressing  key, click the needle bar for replacement. All identical needle bars are now selected, proceed by replacing needle bar values according to requirements. Press  key once again to exit replacement operation.





After the setting is completed, press  key to save current setting.

# CHANGE WORKING MODE

In working status interface, press  key to change working mode. Change one mode when processing the key once (cycle changing) and the key display is changed along with it. The working modes are  automatic color changing and automatic lifting mode,  automatic color changing and manual lifting mode and  manual color changing and manual lifting mode successively. In manual color changing and manual lifting mode, set color changing sequences are invalid. It still is modified mode after the machine is shut off and powered on again.

# EMBROIDERING MODE SWITCHING – FLOATING MODE

Embroidering mode switching is mainly to achieve compensation operation. The user can move the embroidery needle to specified location via air embroidering-floating mode.

In working status interface, press  key to change the embroidery mode. Change one mode when processing the key once (cycle changing) and the key display is changed along with it. The embroidering modes are  normal embroidering,  low speed empty stitch embroidering,  high speed empty stitch embroidering, and  positioned emptying successively.

 **Low Speed Empty Stitch Embroidering:**

In stop status, press start key (low speed empty forwarding) once and the spindle is not moved. The hoop is forwarded along the embroidering stitches. Press stop key again and stop low speed forwarding.

In stop status, press stop key (low speed empty backing) once, and the spindle is not moved. The hoop is backed along the embroidering stitches. Press stop key again and stop low speed backing.

 **High Speed Empty Stitch Embroidering:**

In stop status, press start key (high speed empty forwarding) once and the spindle and the hoop are not moved. Embroidering stitches are increased. Press stop key again, and the hoop is moved to stitch forwarding position directly.

In stop status, press stop key (high speed empty backing) once and the spindle and the hoop are not moved. Embroidering stitches are decreased. Press stop key again, and the hoop is moved to stitch backing position directly.



### Positioned emptying:

In stop status, key on right side is switched to the positioned emptying operation interface.



### Adding Specified Stitches:

After pressing the key, a figure keyboard is popped out. Press figure key to input required stitches. Press  key and the hoop is moved to specified stitches and stopped automatically.



### Reducing Specified Stitches:

After pressing the key, a figure keyboard is popped out. Press figure key to input required stitches. Press  key and the hoop is moved to specified stitches and stopped automatically.



### Forwarding One Color:

After pressing the key, it is moved to start position of following color and stopped automatically.





### Backing One Color:

After pressing the key, it is moved to start position of following color and stopped automatically.

## OPERATION OF RETURNING TO EMBROIDERING POINT IN POWER FAILURE

The operation is mainly applied for sudden power failure in embroidering process and when the hoop appears blocking. It takes operation after powering on. When the hoop type is "Other," the operation is only valid when absolute origin of hoop is searched before embroidering.

In working status, press  key to enter into machine operation interface. Press  and the system prompts "Press OK to start searching absolute origin". Press  key to start searching absolute origin. Then it is moved to embroidering position before power failure and stopped. Draw the bar and it can continue embroidering.

## EMBROIDERY RUNNING SPEED STATUS

In embroidering running status, it can only take Frame Shift Direction and Frame Shift Speed.



Press the plus and minus  key to slow or accelerate the current speed. The section in the middle will display the speed your machine is running at. The top number is the speed you have selected to run your machine at, and the bottom number is the actual speed the machine is running at.

Press  key to select the shifting speed. In the center of the directional arrows, you will find the “frame shift direction and speed” key. You will use this key to increase or decrease the speed by increments and to control how fast the frame moves. To adjust the increments, simply tap on the key until you reach your preferred frame shift direction speed setting.

If the key is displaying two arrows, tapping the plus or minus button will increase or decrease the speed by 50 stitches per minute. If the key is displaying one arrow, tapping the plus or minus button will increase or decrease the speed by 10 stitches per minute.

## ON-BOARD LETTERING

To create personalization directly on your machine first make sure the “Embroidery Status” is unlocked. If it’s locked, select the “Embroidery Status” key represented by the lock icon on the top right corner. Press “OK” to remove the embroidery status.

Now, select the  key on the bottom right corner of your panel. Then press  key to enter into letter interface (Fig. 102).





Type the letters or numbers you would like to use for your personalization. Press  key to switch upper-case and lower-case letters. Press  key to clear letter. After entering is completed, press  key to skip to setting interface. Now, select a font to use from the bottom row of font options and press  . Your personalized design will now appear on the screen.



Figure 102

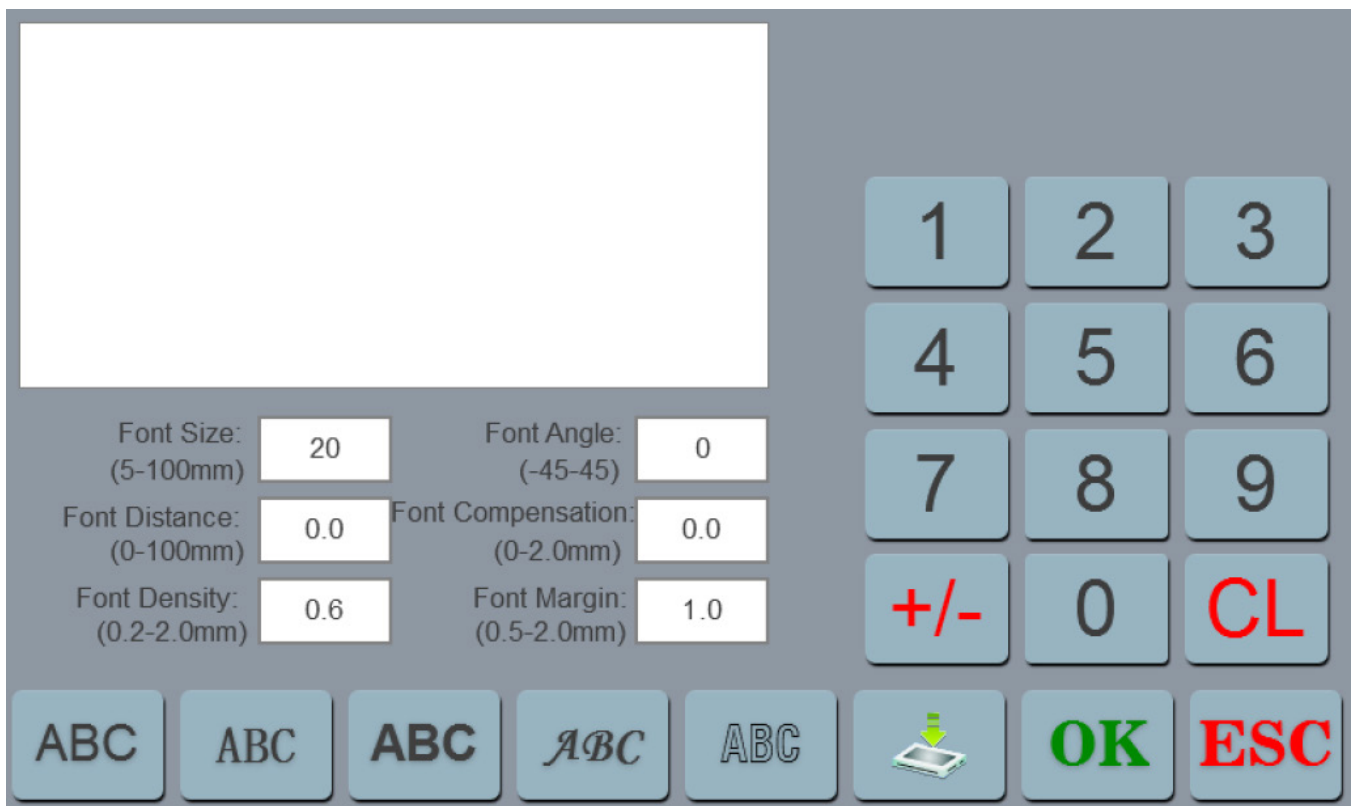
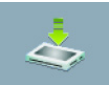



Figure 103

You may now edit your design to add more density, distance, size, compensation or more. When you make a selection, press the Clear button (labeled CL) and then input the desired value and press OK. After setting is completed press **OK** key to generate letter pattern changes. On the left upper corner, it can see the generated embroidery card. Press  key to import the design into the machine's memory. Now, click on the **ESC** key twice to navigate back to the main screen.

Next, click on the  key and look into your machine's memory list to see your design. It will be displayed as the last import on your list. Last, select your design, and press.

## MANUAL TRIMMING

Either in embroidery preparation or working status, it can take trimming operation.

Press  key on panel to take bottom facial suture trimming operation.

## START AND STOP EMBROIDERING

When all design settings have been selected on your machine and you are ready to embroider, press the "Start" button located on the bottom of your control panel. Your machine will now start embroidering.

To stop the project, press the "Stop button" located on the bottom right corner of your panel. This button also works for rewinding your design when you've had a thread break. If you are experiencing this, please refer to the "How to Rewind your Design" for the step-by-step process.

## MACHINE HEAD INDICATOR LIGHTS

When working status, the indicator light is green (See Fig. 104).

Encountering a thread break while embroidering, the indicator light will be red.

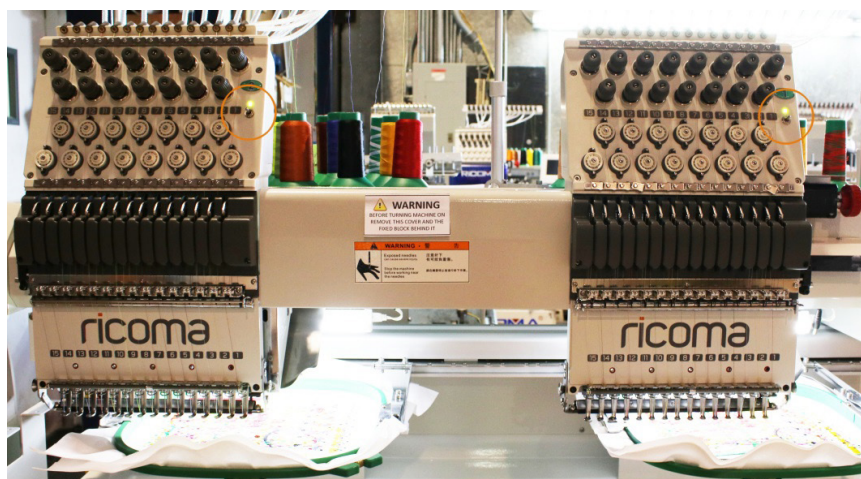

Figure 104

# HOW TO REWIND YOUR DESIGN

To back up, hold the “Stop” button and the machine will float backwards through the design. Once you get to the point you want, hit the stop button again to secure the position to start again from. Then, before you press the start button, locate the light switch on the top right corner of the machine’s head (See Fig. 105). This will be located underneath the head indicator light. Flip the “Light Switch” up once so it turns to red, this will tell the machine it’s in repair mode. Then press the “Start” button and the design will start from that point and stitch over the missed part. If you don’t flip the “Light Switch” up, the machine will float through the design and not stitch until the point where the thread break occurred.

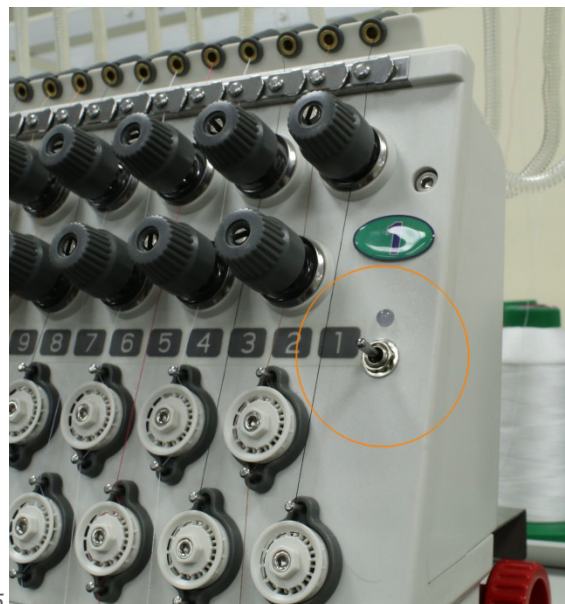
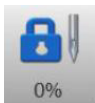

Figure 105



# EMBROIDERY PROCESS FROM START TO FINISH

## 1. Exit work status

In working status, press  key and pop up “Remove embroidery status”. Press **OK** key to enter into preparation status.

## 2. Select a design

If you need to import a design please refer to “How to Upload a Design” on Page 60.

If the design it’s already imported into the machine’s memory, go into  then select the machine’s memory icon .

Look for the DST file name of your logo.

Once you select it press **OK**.

### 3. Select a hoop

Go into design set by pressing on the  key.

Select the hoop selection key  .

Select the pre-hoop size you will be using that fits your design. (**NOTE:** The frame will move and center the design if the DST was centered when digitized)



Press  to return to the main menu screen.

### 4. Select the color sequence

Press  key to enter the color selection window. Select your color sequence according to the color sequence (color film/color analysis) printed out from your embroidery software.

Keep in mind, the colors on the panel are just default colors. You need to choose the number of the needle that has the color spool needed for your design.



Press  followed by  to save and continue to the main menu screen. If needed, you can add the offset or low option to any specific color stops (See Fig. 106).



Figure 105



## 5. Trace your design

Tracing your design it's a really important step that cannot be skipped.

Press the tracing  key on the main menu and see how your machine's head will move to needle #1 and do a complete tracking of your design.

Tracking your design will eliminate the option of hitting a hoop.



When pressing the  key, a message staying "Enter embroidery status" will appear, press **OK**.



After doing the tracing of your design if you are in need of moving your design placement, use the directional  keys on your panel and then press  again to make sure the placement is correct.

## 6. Press start

After tracing, you are now inside the embroidery status and you can start embroidering by pressing the "Start" button on the bottom of the panel.

# CAP OPERATION

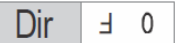
**Note:** Before installing the cap driver into your MT Series machine you must be into the embroidering preparation status and switch the frame to "Cap". To stitch to a cap, switch to cap mode by going into Design Set  then into the hoop selection option  and select  the pre-set hoop selection.

Changing this setting changes the limit switch settings of the machine to be appropriate for the smaller size of the cap frame. The limit switches are intended to stop the machine when you are about to exceed the size of the frame to avoid possible damage. If your design exceeds the limits of the cap frame, you will see a limit error message. To avoid getting this message which will stop the machine during embroidery, always trace the design. To trace, press the Trace  Design Key. This display indicates that the machine is properly set to run a cap  **Dir**  **F**  **0**. The design is rotated 180 degrees as indicated by the F symbol, and the cap icon indicates that the machine has been placed in cap operation mode.

**TIP:** When embroidering caps, change needles often. The tough backing in caps dulls needles quickly. Change about every eight hours of needles use.

## CAP SELECTION

Choose a cap that fits your frame. The shape of the visor board inside your cap should match as closely as possible to the curvature of your cap frame. Mike Meade, owner of Pacesetter Caps, recommends that you cut the visor board off a cap and place it against your frame. If there are large gaps at the center or sides, registration problems are likely to occur in these locations.

If the cap doesn't fit your frame order samples of caps in the styling that you want, search until you find one that does fit more closely. Choose the best cap that your customer's budget will allow. Cheap caps result in high wastage rates, which translate to expensive machine time for which you will not be paid. Then factor in the extra time that operators spend in trying to get acceptable sewing quality on the cap, and possible reprogramming time.

**TIP:** You may need to tighten your bobbin case slightly when embroidering caps to prevent bobbin thread from showing on the top of the embroidery.

## CAP FRAMING

Frame snugly. As with flat goods, the better the goods are framed, the better the resulting embroidery quality.

Frame consistently. When you do the framing operation the same way every time, it is more likely that caps will come out centered and straight. Avoid pulling on the cap when it is in the frame, because this can result in crooked embroidery.

## CAP SEWING TECHNIQUES

Try toppings and backings for clarity. It seems impossible that a cap could benefit from additional backing, but it can. Especially if the backing is adhered to the frame. Many embroiderers like to use a 3oz. tear-away product inside their caps for better clarity on lettering and detail. Toppings are beneficial on heavy twill, corduroy, PolarFleece® and other textured cap fabrics.

You may need to tighten the tension on the bobbin case. For some reason, sewing in the round makes our bobbin want to pull up to the top side of the work. It helps to use a spun polyester bobbin on caps because it has more texture and is easier to keep balanced. Many embroiderers keep a set of cases adjusted for caps.

# CAP PROGRAMMING

Tell your digitizer that the design will be for a finished cap.

Your digitizer will use special techniques like:

- Reduce or eliminate details and outlining where possible.
- Increase column width. The X-axis columns tend to sew narrower on caps than on flat goods.
- Lengthen fill stitch length to reduce needle penetrations and stress on cap. Longer fill stitch length on a cap does not affect its service ability, reduces stress (on you and the cap) and run time.
- Enlarge lettering to at least 3/8" in height if possible.
- Digitize in independent sections. Results in more color changes, but improves registration on many designs.
- On six-panel caps many digitizers like to "tie" the two panels together and cover with stitches. The two front panels are actually separate and need to be unified and stabilized.
- Work from the center out. There is debate concerning this technique, but for certain designs, there is little doubt that it helps to cover the center of the cap first.

# LUBRICATION

Lubrication of your machine is really important to help maintain the life and functionality of your machine. When using your machine constantly you will need to lubricate some important points on your machine so the machine runs smoothly. A lot of troubleshooting can be occurring because the machine is missing lubrication. Lubrication should be done with sewing machine oil and white lithium grease only. Before using any other product please ask a certified technician to confirm the product is safe for your machine.

When using your machine constantly for at least 8 hours a day make sure to lubricate the following points.

1. Daily, remove the bobbin case and clean the hook assembly area with a soft brush, air compressor with a moisture filter or approved canned compressed gas product, such as Dust Off.

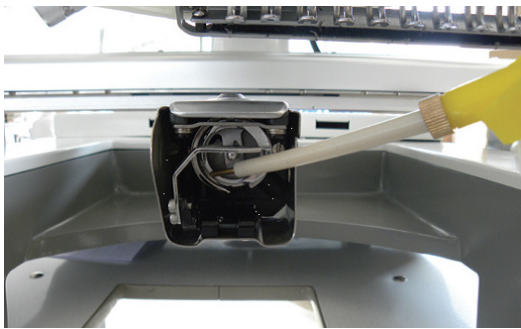

Figure 106



Figure 107



Figure 108



Figure 109

2. Twice a day, with the bobbin case removed, place 2 to 3 drops of sewing machine oil on the race of the rotary hook, where the two sections of the hook meet. See Figure 106.
3. Once or twice a week remove the needle plate located on top of the sewing arm and it is attached with two screws. Once removed clean around the trimmer knives with a soft brush, air compressor with a moisture filter or approved canned compressed gas product, such as Dust Off. See Figure 107.
4. Once a week, place a drop of sewing machine oil directly on the needle bar through the slots in the needle case. Alternate between lubrication the upper and lower needle bar sections. See Figure 108.
5. Once a week, add 2-3 drops of sewing machine oil to the track of the needle bar case which will be the silver metal track. You will be able to see this track when you move your machine's heads to needle #1 and needle #15. See Figure 109.
6. Once every three-five months add white lithium grease on the color change motor located next to the red passive knob. See Figure 109. Also apply grease on the black metal bar that will show when having your machine on needle #1. Then move your machine to needle #15 and apply grease on the black metal bar that will show on the other side. See Figure 109.



Figure 110

7. Once every three-five months add white lithium grease on the edges of each head as show on Figure 110.
8. On the back of the head apply white lithium grease on the metal rollers every three to five months. Move the machine's head from needle #1 to needle #15 to be able to see and apply the grease on all metal rollers. See Figure 111.
9. On the back of the heads, behind the needles you will find the lower guide rail. Apply white lithium grease every three to five months. See Figure 112.
10. Remove the metal cover in between the two heads and apply white lithium greasy on the metal bars that connect both heads. See Figure 113.



Figure 111

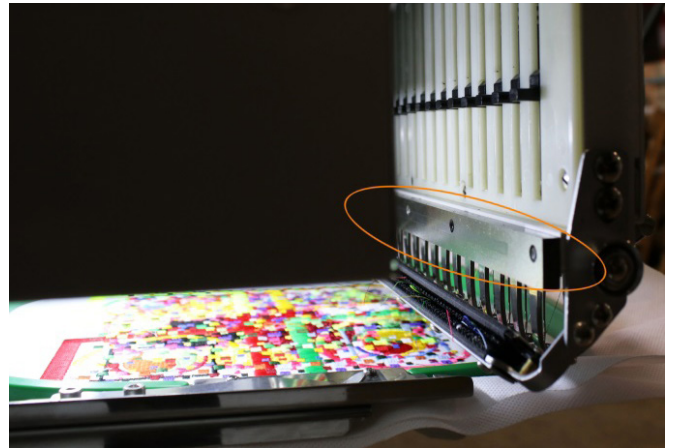

Figure 112

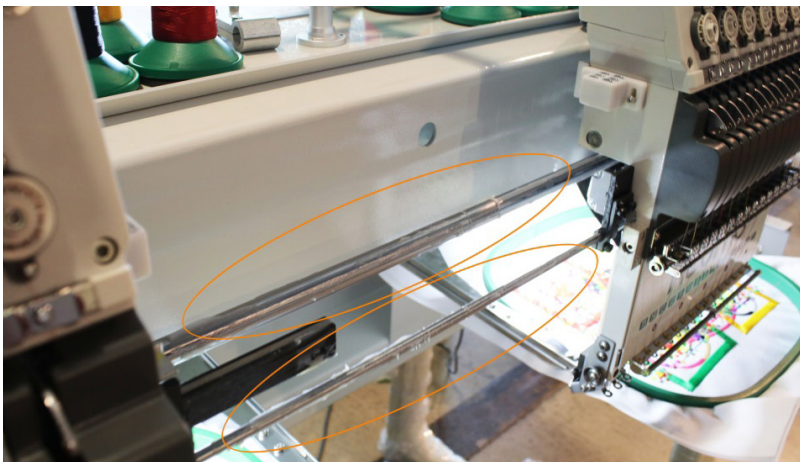

Figure 113

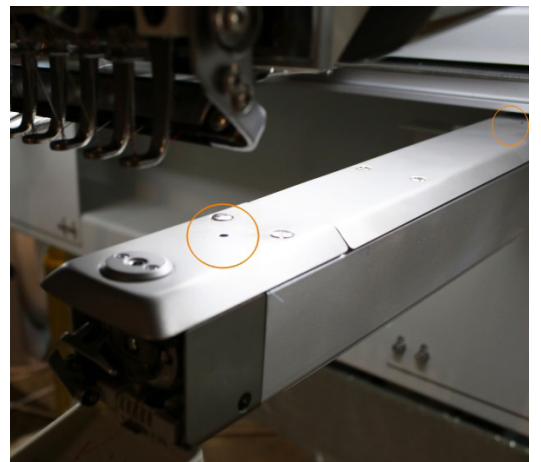

Figure 114

11. Once a week, add 2-3 drops of oil on each port on the cylinder arm. One is just behind the needle plate and the other is at the rear of the cylinder arm. See Figure 114.

Don't over-oil. After oiling, stitch on a test swatch before returning to production to assure excess oil doesn't stain garments.

Keep in mind your machine comes with a lubrication label (See Figure 115) that provides the key points and suggested time frame for each of them. If further assistance is needed for maintenance of your machine, please contact your local certified ricoma technician.

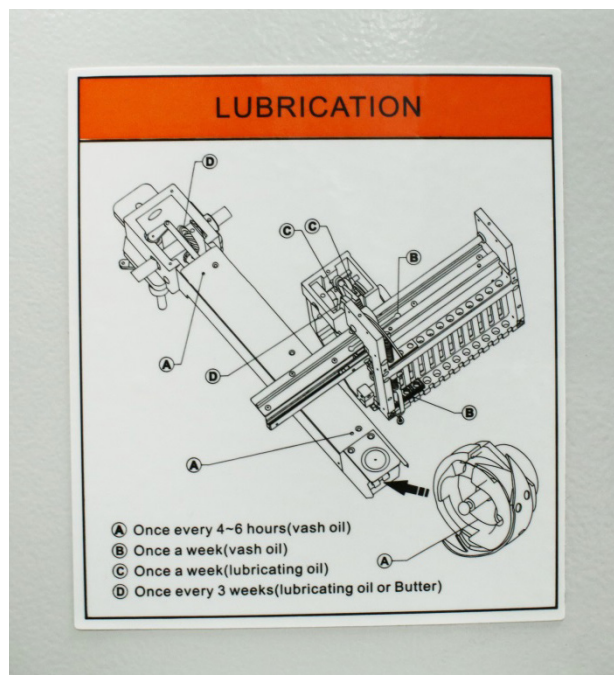

Figure 115

## CARE OF THE BOBBIN CASE

Clean lint from beneath the tension plate with the corner of a business card, or remove it with the bobbin thread itself used like dental floss.

Resist the temptation to blow the lint off the case—this deposits damaging saliva on your bobbin case.

## COMMON ERRORS

### Emergency stop error

This is caused when the Emergency Stop switch has been pushed in usually during shipping or under an emergency (panic) situation. If you get a dialogue box on the screen stating "Emergency Stop!" or the machine is beeping resolve this issue by turning the Emergency Stop switch in the direction of the arrows indicated on the face of this button (clockwise). Be sure to not pull it out. It will pop out by itself, when your turn it. Pulling on it could damage the switch.

## Needle error / color change error

This means the machine does not recognize which needle is over the needle plate. This might be because the embroidery head is positioned between two needle positions. This often happens during shipping. Also, when the machine is performing a color change, there is a drop in the power supply, coming to the embroidery machine. This can also happen if by accident the passivity knob behind the embroidery head is turned. If you get a dialogue box on the screen

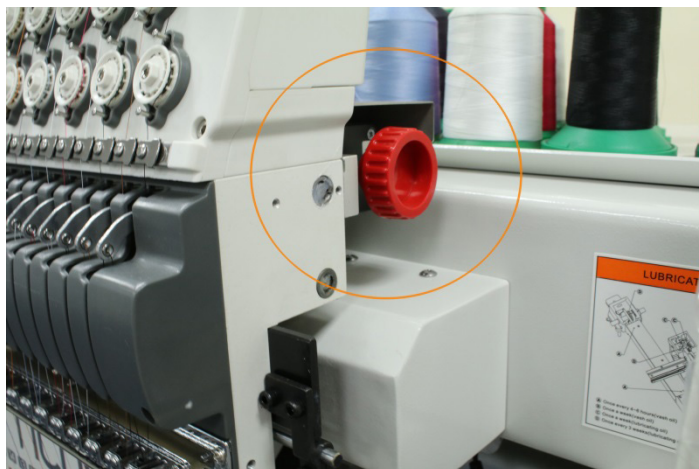

Figure 116

stating “Needle Error!” the machine is beeping and on the needle display on the panel shows a “0” or question mark resolve this issue by first pressing ESC to clear the dialogue box. Locate the passivity knob located on the right side of head #1 (See Figure 116). Then very slowly turn the red passivity knob until there is any number from #1 - 15 where the “0” was displayed.

## Main axis error or main axis not at 100 degrees

The machine needs to be at 100 degrees for normal operations. An error 100 or main axis error means the main axis (shaft) is not lined up on 100 degrees, which is the proper position for the machine to start and stop sewing. This error can be caused if a needle hits the hoop, if you get a bad bird nest, during shipping, or by accidentally turning the black knob on the side of the machine near the sight window.

To correct this error you can use the 100-degree key on your panel, which automates the process of aligning your machine to 100 degrees.

If you get a dialogue box stating “Main Axis not at 100 degrees”, the machine is beeping, and on the control panel the shaft indicator display is not at 100 or it has a “?” this can be resolved by clearing out the message by pressing “OK”. Then make sure there is a needle number displayed on the panel. If no needle is displayed please refer to “Needle Error” to allocate a needle on your machine. Then, press the one hundred degree button on your control panel. Most of the time, your machine’s main axis will align itself after this step, and you may continue operating your machine.

If you are still receiving an error message after performing this step, you will need to align it manually using the degree wheel on the left side of your machine. Look into the sight window located on the left side of the machine or at the main shaft indicator display on the control panel. This will show you which degree the machine is currently aligned to. Then using an Allen wrench

turn counterclockwise to about 2-3 full turns until the display reads 100. On the site window, the red dot should be line up with the 100 degree line. Then press the 100 degree key on your panel.

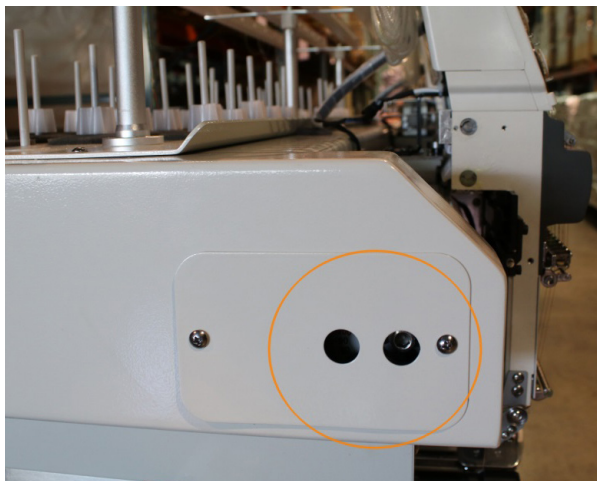

Figure 117

If you continue having this error, make sure there is a needle number displayed on your panel. Then turn off the machine. Then look into the site window located on the left side of the machine or at the main shaft indicator display on the control panel See Figure 117. Then using an Allen wrench turn counterclockwise to about 2-3 full turns until the display reads 100. On the site window, the red dot should be line up with the 100 degree line. Turn on your machine. When the main menu displays press the 100 degree key on your panel.

## Resolving a thread break

When a thread breaks occurs the machine will stop and starts beeping. The thread almost always will break at the lower portion of the embroidery head. To fix this issue thread the machine from where the thread is broken all the way though the needle and down the presser foot. Then hold the thread into the holding spring and leave around 1 inch of thread hanging. If too much thread is left on the spring it will not be pulled to the underside of the embroidery. If too little thread is left the thread will not catch the bobbin.

Now that you have threaded the machine you need to back up the machine so you do not have any missed stitches on your design. When a thread breaks occurs the machine continues to advance forward momentarily so it's recommended to back up so there is no gap or missed stitch areas on your design. To rewind, press the "STOP" button to back up and let the machine back up for approximately 10-12 stitches. Then press the "STOP" button again to stop the machine from backing up further. Now press the "START" button to resume sewing your design.

## Bobbin runs out

When the bobbin runs out the machine will stop and start beeping. On your MT series a message with "T.Break" will show on your panel. You will know the difference between a thread break and a bobbin run out because the top thread will still be attach to the garment. Proceed to remove the bobbin case from the rotary hook. Remove the old bobbin and replace it with a new bobbin. Insert the bobbin case back into the machine. Now proceed to back up your machine so there is no missed stitches left behind.



**ricoma**

*THINK BEYOND*

## **RICOMA HEADQUARTERS IN USA**

### **Ricoma International Corporation**

3450 NW 114th Ave., Miami, FL 33178, USA

Telephone: (305) 418-4421 | Fax: (305) 418-5036

Toll Free: 1-888-292-6282

**[www.ricoma.com](http://www.ricoma.com)**

**[info@ricoma.com](mailto:info@ricoma.com)**